

KENWOOD

UD COMPONENT SYSTEM / COMPACT HI-FI SYSTEM

UD-700 UD-700M

INSTRUCTION MANUAL

KENWOOD CORPORATION

This manual contains instructions for two models.
Model availability and features (functions) may differ
depending on the country and sales area.

COMPACT
disc
DIGITAL AUDIO

Introduction

Your choice of this product indicates that you are a devotee to excellence in sound reproduction.

We appreciate your patronage and take pride in the long tradition of quality components that our company represents.

So that you can get the most out of your unit, we suggest that you take the time to read through this manual before you hook up and operate your system. This will acquaint you with operating features and system-connection considerations so that your listening pleasure will be enhanced right from the start. You will notice that in all aspects of planning, engineering, styling, operating convenience and adaptability we have sought to anticipate your needs and desires.

Keep this manual handy for future reference.

For your records

Record the serial number, found on the back of the unit, in the spaces designated on the warranty card, and in the space provided below. Refer to the model and serial numbers whenever you call upon your dealer for information or service on this product.

Model _____ Serial Number _____

Unpacking

Unpack the unit carefully and make sure that all accessories are put aside so they will not be lost.

Examine the unit for any possibility of shipping damage. If your unit is damaged or fails to operate, notify your dealer immediately. If your unit was shipped to you directly, notify the shipping company without delay. Only the consignee (the person or company receiving the unit) can file a claim against the carrier for shipping damage.

We recommend that you retain the original carton and packing materials for use should you transport or ship the unit in the future.

The marking of products using lasers (Except for some areas.)

**CLASS 1
LASER PRODUCT**

The label is attached to the rear panel and says that the component uses laser beams that have been classified as Class 1. It means that the unit is utilizing laser beams that are of a weaker class. There is no danger of hazardous radiation outside the unit.

WARNING NOTICE:

IN MOST CASES IT IS AN INFRINGEMENT OF COPYRIGHT TO MAKE COPIES OF TAPES OR DISCS WITHOUT THE PERMISSION OF THE COPYRIGHT OWNERS. ANYONE WISHING TO COPY COMMERCIALY AVAILABLE TAPES OR DISCS SHOULD CONTACT THE MECHANICAL COPYRIGHT PROTECTION SOCIETY LIMITED OR THE PERFORMING RIGHTS SOCIETY LIMITED.

When your unit needs to be repaired, bring the entire set (Speakers excluded) to your dealer.

Accessories

- AM loop antenna 1
- FM indoor antenna 1

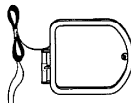

- Loop antenna stand 1
- Antenna adaptor (75Ω / 300Ω) 1
(For U.K. and Europe)



- Batteries (R03 / AAA) 2
- Remote control unit 1



- AC plug adaptor 1
(Except for some areas)
- Speaker cords

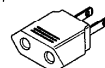

For the unit with a European AC plug in areas other than Europe.

Speaker cords are packed with the speakers. Remote control unit is packed with the graphic equalizer unit. All other accessories are packed with the receiver unit.

- Magazine 1
(UD-700M only)



This accessory is packed with the CD player.

Contents

Caution : Read the pages marked carefully to ensure safe operation.

Introduction	2	Operation of graphic equalizer	28
△ Before applying power	3	Playing CDs (UD-700)	37
△ Safety precautions	3	Playing CDs (UD-700M)	42
△ IMPORTANT SAFEGUARDS	4	Playback operation of cassette decks	50
Before operation	6	DPS operation	52
FM DE-EMPHASIS / CHANNEL SPACE switch	7	Recording operation on cassette deck (Deck B only)	54
System connections	8	Recording of CD playback (CCRS)	58
Connection of Audio / Visual components (optional)	12	Tape dubbing	64
Controls and indicators	13	Operation with video components	65
Operation of remote control unit	18	Simple Karaoke singing entertainment	66
Listening to sound	20	Presence effect	67
Time adjustment	21	Operation of timer	71
Audio adjustment	22	In case of difficulty	79
Reception of radio broadcast	24	Specifications	82

Before applying power

 **Caution: Read this page carefully to ensure safe operation.**

For the U.S.A. and Canada

Important!

Units shipped to the U.S.A. and Canada are designed for operation on 120 volts AC only.

CAUTION: TO PREVENT ELECTRIC SHOCK DO NOT USE THE AC PLUG WITH AN EXTENSION CORD, RECEPTACLE OR OTHER OUTLET UNLESS THE BLADES CAN BE FULLY INSERTED TO PREVENT BLADE EXPOSURE.

For Australia and Europe

Important!

Units shipped to Australia are designed for operation on 240 V AC only.

Units shipped to Europe are designed for operation on 230 V AC only.

For the United Kingdom

Important!

Units shipped to the U.K. are designed for operation on 240 volts AC only.

The mains plug must be removed from the wall socket prior to any internal examination.

The wires in this mains lead are coloured in accordance with the following code:

Blue Neutral
Brown Live

The wires in this mains lead must be connected to the terminals in the plug as follows:

Wire colour	Plug terminal marking
Blue	N or Black
Brown	L or Red

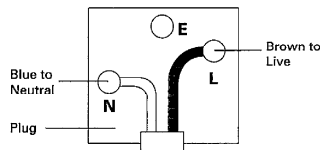

Notes:

1. If a 13-amp plug is used, this must be fitted with a 13-amp fuse.
2. If a 3-pin plug with earthing contact is used, no wire must be connected to the E terminal.

For other countries

Important!

Units shipped to countries other than the above countries are equipped with an AC voltage selector switch on the rear panel. Refer to the following paragraph for the proper setting of this switch.

AC voltage selection

This unit operates on 110 - 120 or 220 - 240 volts AC. The AC voltage selector switch Type A or Type B on the rear panel is set to the voltage that prevails in the area to which the unit is shipped. Before connecting the power cord to your AC outlet, make sure that the setting position of this switch matches your line voltage. If not, it must be set to your voltage in accordance with the following direction.

AC voltage selector switch

Type A

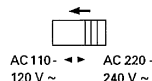

Type B

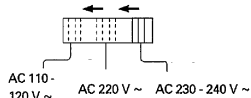





Move switch lever to match your line voltage with a small screwdriver or other pointed tool.

Note:

Our warranty does not cover damage caused by excessive line voltage due to improper setting of the AC voltage selector switch.

Safety precautions

WARNING: TO PREVENT FIRE OR ELECTRIC SHOCK, DO NOT EXPOSE THIS APPLIANCE TO RAIN OR MOISTURE.

 <div style="text-align: center;"> <p>CAUTION</p> <p>RISK OF ELECTRIC SHOCK DO NOT OPEN</p> </div> 	<p>CAUTION: TO REDUCE THE RISK OF ELECTRIC SHOCK, DO NOT REMOVE COVER (OR BACK). NO USER-SERVICEABLE PARTS INSIDE, REFER SERVICING TO QUALIFIED SERVICE PERSONNEL.</p>
	<p>THE LIGHTNING FLASH WITH ARROWHEAD SYMBOL, WITHIN AN EQUILATERAL TRIANGLE, IS INTENDED TO ALERT THE USER TO THE PRESENCE OF UNINSULATED "DANGEROUS VOLTAGE" WITHIN THE PRODUCT'S ENCLOSURE THAT MAY BE OF SUFFICIENT MAGNITUDE TO CONSTITUTE A RISK OF ELECTRIC SHOCK TO PERSONS.</p>
	<p>THE EXCLAMATION POINT WITHIN AN EQUILATERAL TRIANGLE IS INTENDED TO ALERT THE USER TO THE PRESENCE OF IMPORTANT OPERATING AND MAINTENANCE (SERVICING) INSTRUCTIONS IN THE LITERATURE ACCOMPANYING THE APPLIANCE.</p>

IMPORTANT SAFEGUARDS

⚠ Caution : Read this page carefully to ensure safe operation.

Please read all of the safety and operating instructions before operating this unit. For best results, follow all warnings placed on the unit and adhere to the operating and use instructions. These safety and operating instructions should be retained for future reference.

1. Power sources — The unit should be connected to a power supply only of the type described in the operating instructions or as marked on the appliance.

2. Power-cord protection — Power-supply cords should be routed so that they are not likely to be walked on or pinched by items placed upon or against them, pay particular attention to cords at plugs, convenience receptacles, and the point where they exit from the unit.

Never pull or stretch the cord.



3. Grounding or polarization — The precautions should be taken so that the grounding or polarization means of this unit is not defeated.

4. Ventilation — The unit should be situated so that its location or position does not interfere with its proper ventilation.

To maintain good ventilation, do not put records or a table-cloth on the unit. Place the unit at least 10 cm away from the walls.

Do not use the unit on a bed, sofa, rug or similar surface that may block the ventilation openings.

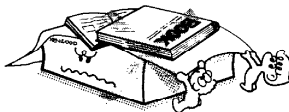

5. Water and moisture — The unit should not be used near water — for example, near a bathtub, washbowl, kitchen sink, laundry tub, in a wet basement, or near a swimming pool, etc.

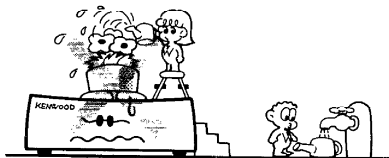

6. Temperature — The unit may not function properly if used at extremely low, or freezing temperatures. The ideal ambient temperature is above +5°C (41°F).

7. Heat — The unit should be situated away from heat sources such as radiators, heat registers, stoves, or other units (including amplifiers) that produce heat.

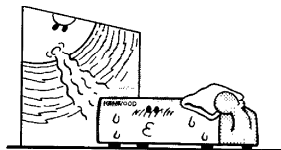

8. Electric shock — Care should be taken so that objects do not fall and liquid is not spilled into the enclosure through openings. If a metal object, such as a hair pin or a needle, comes into contact with the inside of this unit, a dangerous electric shock may result. For families with children, never permit children to put anything, especially metal, inside this unit.

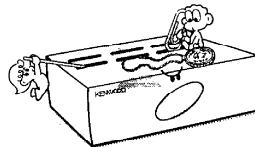

9. Enclosure removal — Never remove the enclosure. If the internal parts are touched accidentally, a serious electric shock might occur.

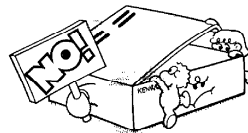

10. Magnetic fields — Keep the unit away from sources of magnetic fields such as TV sets, speaker systems, radios, motorized toys or magnetized objects.

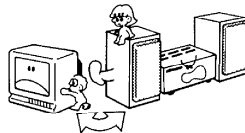

11. Cleaning — Do not use volatile solvents such as alcohol, paint thinner, gasoline, or benzene, etc. to clean the cabinet. Use a clean dry cloth.

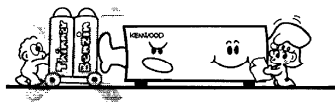

⚠ Caution : Read this page carefully to ensure safe operation.

- 12. Carts and stands** — An appliance and cart combination should be moved with care. Quick stops, excessive force, and uneven surfaces may cause the appliance and cart combination to overturn.



- 13. Nonuse periods** — The power cord of the unit should be unplugged from the outlet when left unused for a long period of time.
- 14. Abnormal smell** — If an abnormal smell or smoke is detected, immediately turn the power OFF and pull out the power cord. Contact your dealer or nearest service center.

POWER OFF!



- 15. Damage requiring service** — The unit should be serviced by qualified service personnel when:
- A. The power-supply cord or the plug has been damaged; or
 - B. Objects have fallen, or liquid has been spilled into the unit; or
 - C. The unit has been exposed to rain; or
 - D. The unit does not appear to operate normally or exhibits a marked change in performance; or
 - E. The unit has been dropped, or the enclosure damaged.
- 16. Servicing** — The user should not attempt to service the unit beyond that described in the operating instructions. All other servicing should be referred to qualified service personnel.
- 17. Outdoor antenna grounding** — If an outside antenna is connected to the receiver, be sure the antenna system is grounded so as to provide some protection against voltage surges and built up static charges. Section 810 of the National Electrical Code, ANSI/NFPA 70, provides information with respect to proper grounding of the mast and supporting structure, grounding of the lead-in wire to an antenna discharge unit, size of grounding con-

ductors, location of antenna-discharge unit, connection to grounding electrodes, and requirements for the grounding electrode. See Figure.

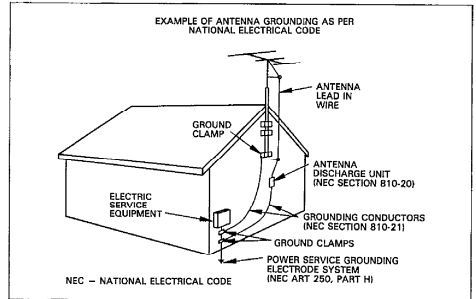

- 18. Power lines** — An outdoor antenna should be located away from power lines.
- 19. AC outlets** — Do not connect other audio equipment with a power consumption larger than that specified to the AC outlet on the rear panel. Never connect other electrical units, such as an iron or toaster, to it to prevent fire or electric shock.

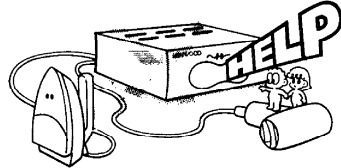

For the U.S.A.

CAUTION:

Use of controls or adjustments or performance of procedures other than those specified herein may result in hazardous radiation exposure.

In compliance with Federal Regulations, following are reproductions of labels on, or inside the product relating to laser product safety.

**KENWOOD CORPORATION
SHIONOGI SHIBUYA BUILDING 17-5
2-CHOME, SHIBUYA, SHIBUYA-KU,
TOKYO, JAPAN**

**KENWOOD CORP. CERTIFIES THIS EQUIPMENT
CONFORMS TO DHHS REGULATIONS NO. 21 CFR
1040.10, CHAPTER I, SUBCHAPTER J.**

Location: Back Panel

Notes:

- 1. Item 3 is not required except for grounded or polarized equipment.
- 2. Item 17 and 18 are not required except for units provided with antenna terminals.
- 3. Item 17 complies with UL in the U.S.A.

Before operation

Notes on cassette tape

Safety tab (accidental erasure prevention tab)

After an important recording has been finished, break the safety tab, to prevent the recorded contents from being erased or re-recorded on accidentally.

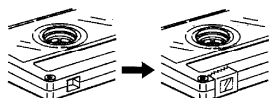
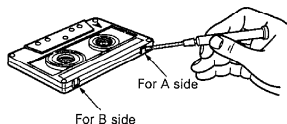

To re-record

Apply tape only to the position where the tab has been removed.

To store cassette tapes

Do not store the tapes in a place which is subject to direct sunlight, or near equipment that generates heat. Keep the cassette tapes away from any magnetic field.

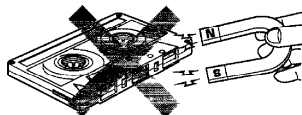

When there is slack in the tape

In such a case, insert a pencil into the reel hole and wind the reel hub to remove the slack.

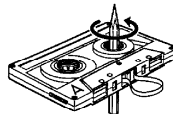

Notes: _____

1. 120-minute cassette tape

Since a 120-minute cassette tape is very thin, the tape could adhere to the pinch roller or be easily cut. It is recommended that these tapes not be used with this unit to prevent possible damage.

2. Endless tapes

Do not use an endless tape, as this could damage the mechanism of the unit.

Cleaning the head section

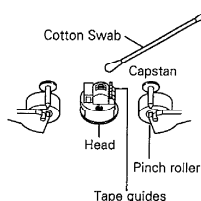

Cleaning the heads and peripheral components

For maintaining the best condition of the deck and for longer service life, always keep the heads (recording / playback / erase), capstan and pinch roller clean. To clean them, perform the following:

1. Open the cassette holder.
2. Using a cotton swab dipped in alcohol, clean the head (recording / playback / erase), capstan and pinch roller carefully.

Demagnetizing the head

When the recording / playback head is magnetized, the sound quality will be deteriorated. In such a case, demagnetize the head using a commercially available demagnetizer (head eraser).

Note: _____

There are precisely aligned parts around the heads, including the tape guides.

When cleaning, pay special attention so as not to apply shock to them.

Beware of condensation

When water vapor comes into contact with the surface of cold material, water drops are produced.

If condensation occurs, correct operation may not be possible, or the unit may not function correctly.

This is not a malfunction, however, and the unit should be dried. (To do this, turn the POWER switch ON and leave the unit as it is for several hours.)

Be especially careful in the following conditions:

- When the unit is brought from a cold place to a warm place, and there is a large temperature difference.
- When a heater starts operating.
- When the unit is brought from an air-conditioned place to a place of high temperature with high humidity.
- When there is a large difference between the internal temperature of the unit and the ambient temperature, or in conditions where condensation occurs easily.

Disc handling precautions

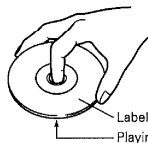

Handling

Hold compact discs so that you do not touch the playing surface.



Do not attach paper or tape to either the playing side or the label side of compact discs.

Caution on disc used

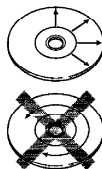
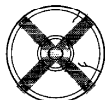

Cleaning

If fingerprints or foreign matter become attached to the disc, lightly wipe the disc with a soft cotton cloth (or similar) from the center of the disc outwards in a radial manner.

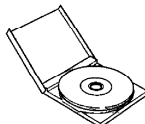

Storage

When a disc is not to be played for a long period of time, remove it from the CD player and store it in its case.

Never play cracked or warped disc.

During playback, the disc rotates at high speed in the player.

Therefore, to avoid danger, never use a cracked or deformed disc or a disc repaired with tape or adhesive agent.

FM DE-EMPHASIS / CHANNEL SPACE switch (Except for some areas)

The FM DE-EMPHASIS / CHANNEL SPACE switch on the rear panel is set to the correct setting that prevails in the area to which the unit is shipped. However, if the FM DE-EMPHASIS / CHANNEL SPACE setting is not matched to the area where the unit is to be used; for instance, when you move from area 1 to area 2 or vice versa, desired reception of AM / FM broadcasts is not expected. In this case, change the FM DE-EMPHASIS / CHANNEL SPACE setting in accordance with the area corresponding to the table. The FM DE-EMPHASIS is switched over at the same time.

- When changing the setting of the FM DE-EMPHASIS / CHANNEL SPACE switch, first disconnect the power cord, then reset the channel space switch, connect the power cord again, and turn the power on.

Area	CHANNEL SPACE freq.	FM DE-EMPHASIS
1. U.S.A., Canada, and, South American countries	FM: 100kHz AM: 10kHz	75 μ s
2. Other countries	FM: 50kHz AM: 9kHz	50 μ s



Dolby noise reduction and HX Pro headroom extension manufactured under license from Dolby Laboratories Licensing Corporation. HX Pro originated by Bang & Olufsen. "DOLBY", the double-D symbol and "HX PRO" are trademarks of Dolby Laboratories Licensing Corporation.

Manufactured under license from Dolby Laboratories Licensing Corporation. Additionally licensed under one or more of the following patents: U.S. numbers 3,632,886, 3,746,792 and 3,959,590; Canadian numbers 1,004,603 and 1,037,877. "Dolby" and the double-D symbol are trademarks of Dolby Laboratories Licensing Corporation.

Memory backup function

Stored contents cleared at least 3 days after the last power OFF (STAND BY mode)	Graphic equalizer (Stored patterns) Cassette deck (Direction and recording level)
Stored contents cleared immediately when power plug in unplugged from power outlet	Clock of receiver unit
Stored contents cleared in at least 3 days after power plug is unplugged from power outlet	Preset stations of receiver unit

Note related to transportation and movement (CD player)

Before transporting or moving this unit, carry out the following operations.

- Turn the power ON but do not load a disc.
- Wait a few seconds and verify that the display shown appears.

UD-700 display

UD-700M display

Without magazine, press the key.

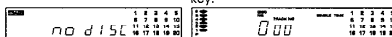

- Turn the power OFF.

System connections

Do not plug in the power cord until all connections are completed.

- When stacking components, follow the indicated order in the connections diagram.
- When connecting the parallel cord, be sure to match the colors of the sockets.
- When connecting the related system components, refer also to the instruction manuals of the related components.
- Align the front panels of the sets flush with each other.

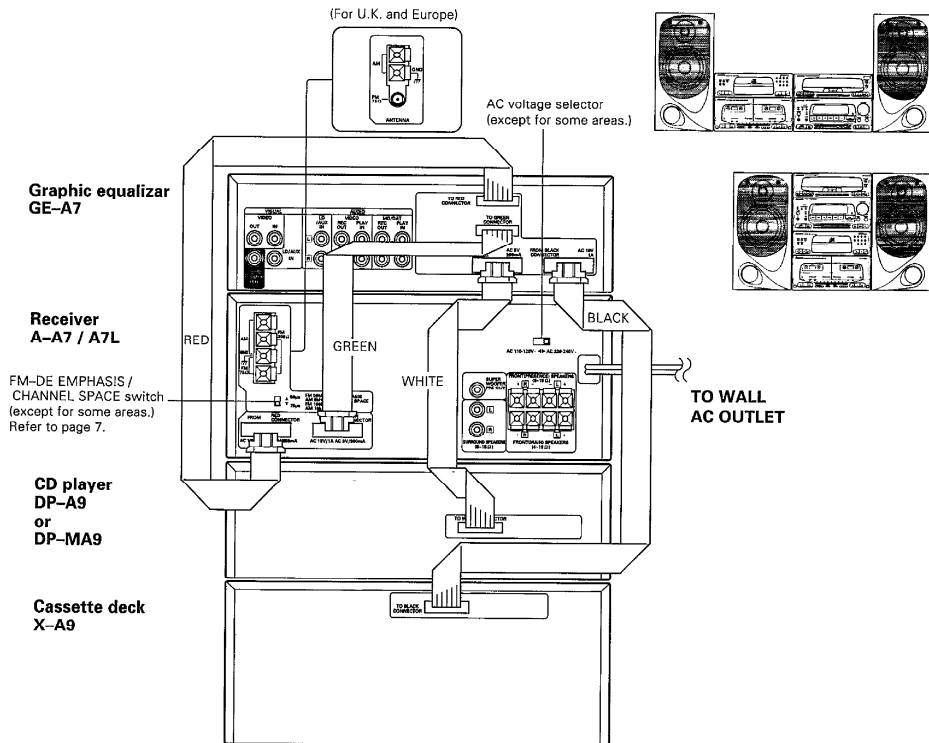

■ Connection of parallel cord

- Hold the connector of the parallel cord in parallel with the socket on the rear panel, and insert securely until it clicks.
- Connect the parallel cord by matching the colors of the connector and socket.
- When unplugging the parallel cord, push and hold the two ends of the connector and pull the connector straight from the rear panel socket.

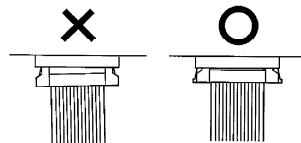
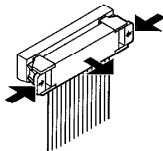

Notes:

- 1 Connect all cords firmly. If connections are loose, there could be loss of sound or noise produced.
- 2 When plugging and unplugging connection cords, be sure to first remove the power cord from the AC outlet. Plugging / unplugging connection cords without removal of the power cord can cause malfunctions or damage to the unit.

Connection method to each antenna terminal

① Push lever.



② Insert cord.



③ Return lever.



■ AM loop antenna connection

The supplied antenna is for indoor use. Place it as far as possible from the main system, TV set, speaker cords and power cord, and set it to a direction which provides the best reception.

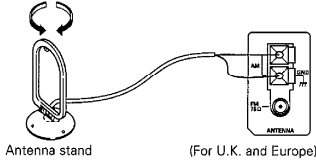

Antenna stand

(For U.K. and Europe)

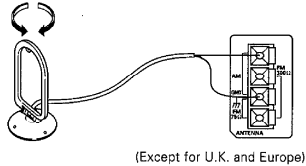

(Except for U.K. and Europe)

■ AM outdoor antenna connection

If the reception is poor when the AM loop antenna is used, distribute a vinyl-coated wire of more than 6 meters outdoors, without disconnecting the loop antenna.

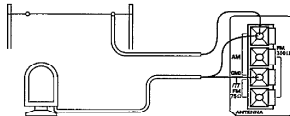
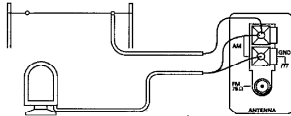

■ FM indoor antenna connection

The supplied antenna is for indoor use. For stable reception, remove the indoor antenna after installing an outdoor antenna as soon as possible.

- ① Find the position that provides best reception.
- ② Fix two ends.

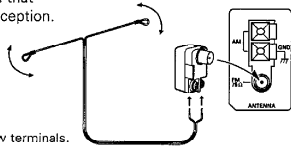

Connect to the screw terminals.

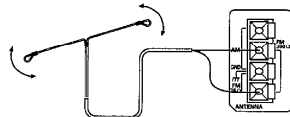

■ FM outdoor antenna connection

It is recommended to install an exclusive FM outdoor antenna to capture FM broadcast with high sound quality. Use a coaxial cable for the connection between the outdoor antenna and FM ANTENNA terminal on the rear panel. For the connection between the coaxial cable and FM ANTENNA terminal, please refer to the illustration.

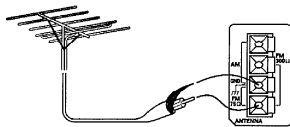
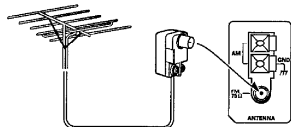

■ 75 Ω coaxial cable connection (Europe and U.K. only)

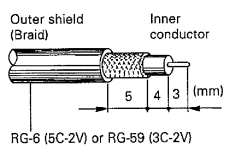
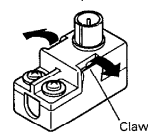
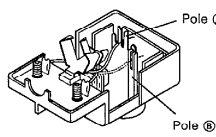
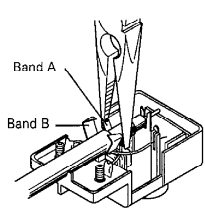
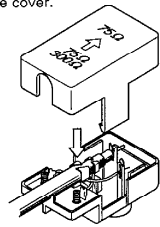
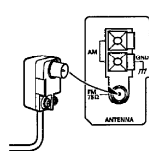
<p>① Arrange the coaxial cable as illustrated.</p>  <p>Outer shield (Braid) Inner conductor</p> <p>5 4 3 (mm)</p> <p>RG-6 (5C-2V) or RG-59 (3C-2V)</p>	<p>② Open the antenna adaptor. Open the claws with the fingers to release the lock and pull out the cover.</p>  <p>Claw</p>	<p>③ Remove the inner conductor from the groove of pole ④ and insert it in the groove of pole ⑤.</p>  <p>Pole ④</p> <p>Pole ⑤</p>
<p>④ Insert into the slit on the clip. Fasten the bands A and B, using a pair of pliers.</p>  <p>Band A</p> <p>Band B</p>	<p>⑥ Close the cover.</p> 	<p>⑦ Connect the adaptor to the antenna terminal.</p>  <p>ANTENNA</p>

Note:

When using a 300 Ω feeder cable, insert its cores into the groove of pole A.

■ Connection of front speakers (For U.K. and Europe)

If you live in other area than these, please refer to the separate speaker instruction manual.

On the speaker:

- ① While pressing lever (holding it)
- ② Insert cord.

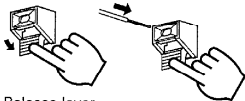

- ③ Release lever.



On the receiver:

- ① Push lever.
- ② Insert cord.



- ③ Return lever.

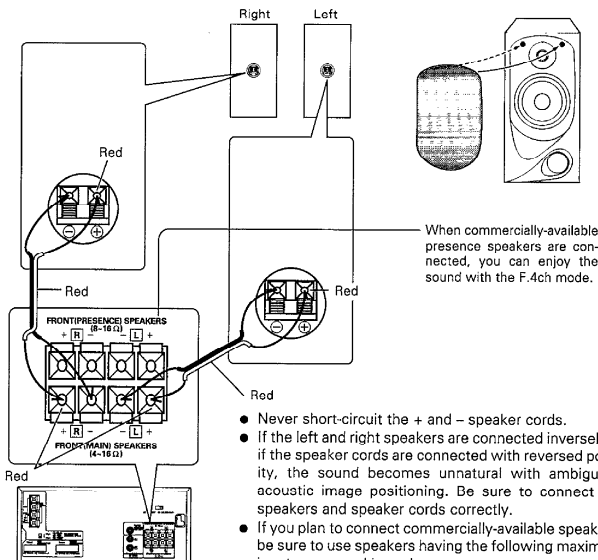

- Never short-circuit the + and - speaker cords.
- If the left and right speakers are connected inversely or if the speaker cords are connected with reversed polarity, the sound becomes unnatural with ambiguous acoustic image positioning. Be sure to connect the speakers and speaker cords correctly.
- If you plan to connect commercially-available speakers, be sure to use speakers having the following maximum input power and impedance.

Front speaker : 4 Ω or more, 60 W or more.
Presence speaker : 8 Ω or more, 25 W or more.

■ Connection of surround (rear) speakers (optional)

Surround (rear) speakers
*CM-5ES or CM-7ES

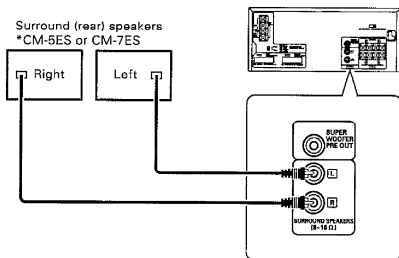

* Not for sale or available in U.S.A. and Canada.

■ Connection of super woofer (optional)

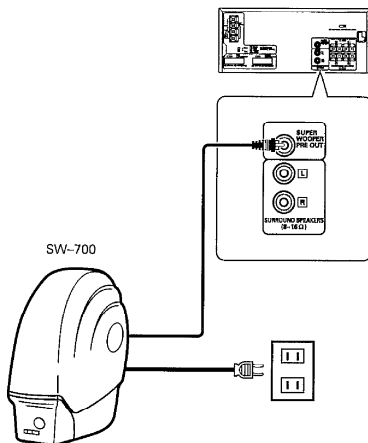

Connection of Audio / Visual components (optional)

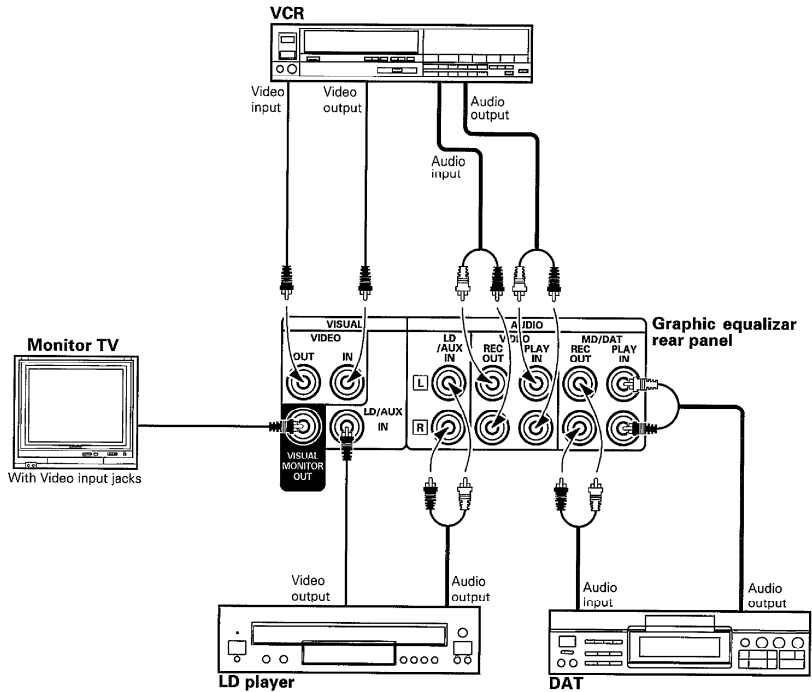

- Connection cords are not supplied with this system.
- Any of the following video equipment can be connected in place of the LD player.
 - DBS tuner
 - Video camera
 - Video recorder
- The DAT input jacks also accept the connection of a MD (mini-disc) player.

Controls and indicators

■ Receiver

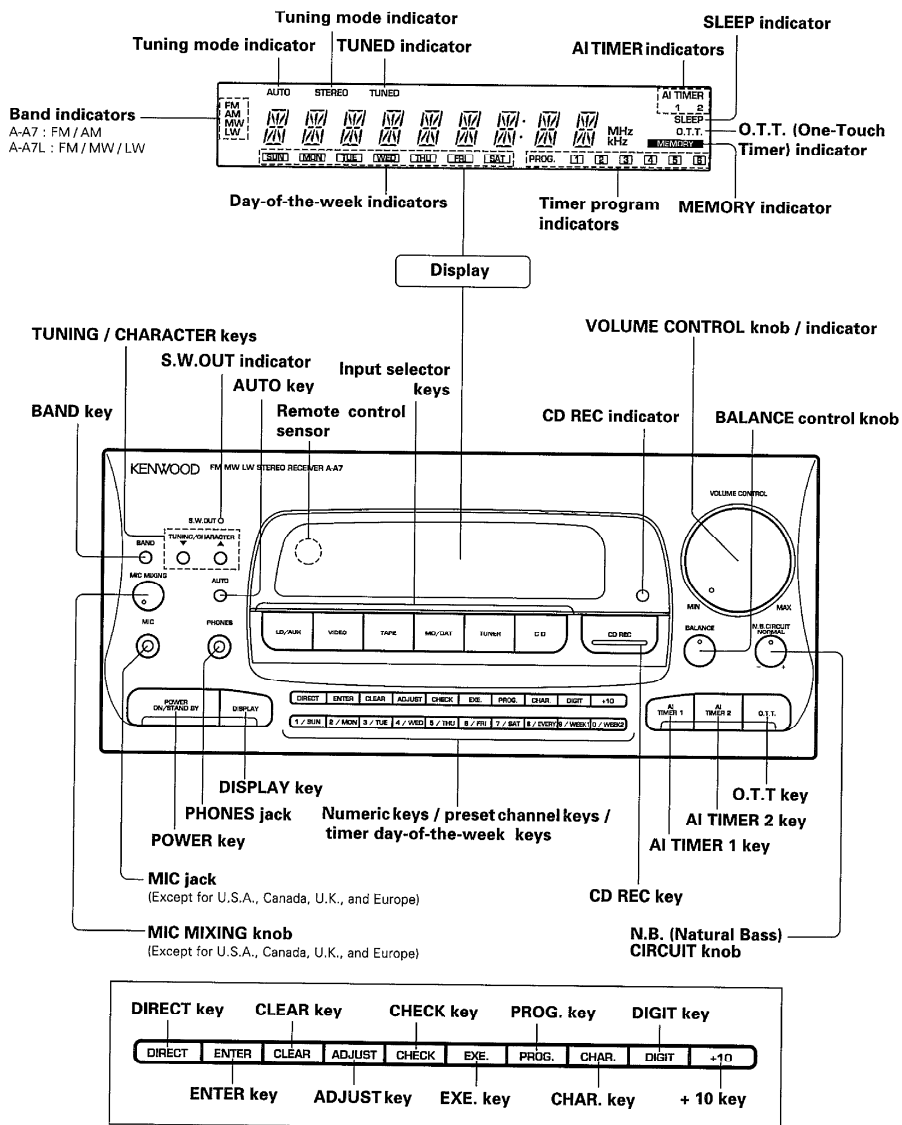

■ Graphic equalizer unit

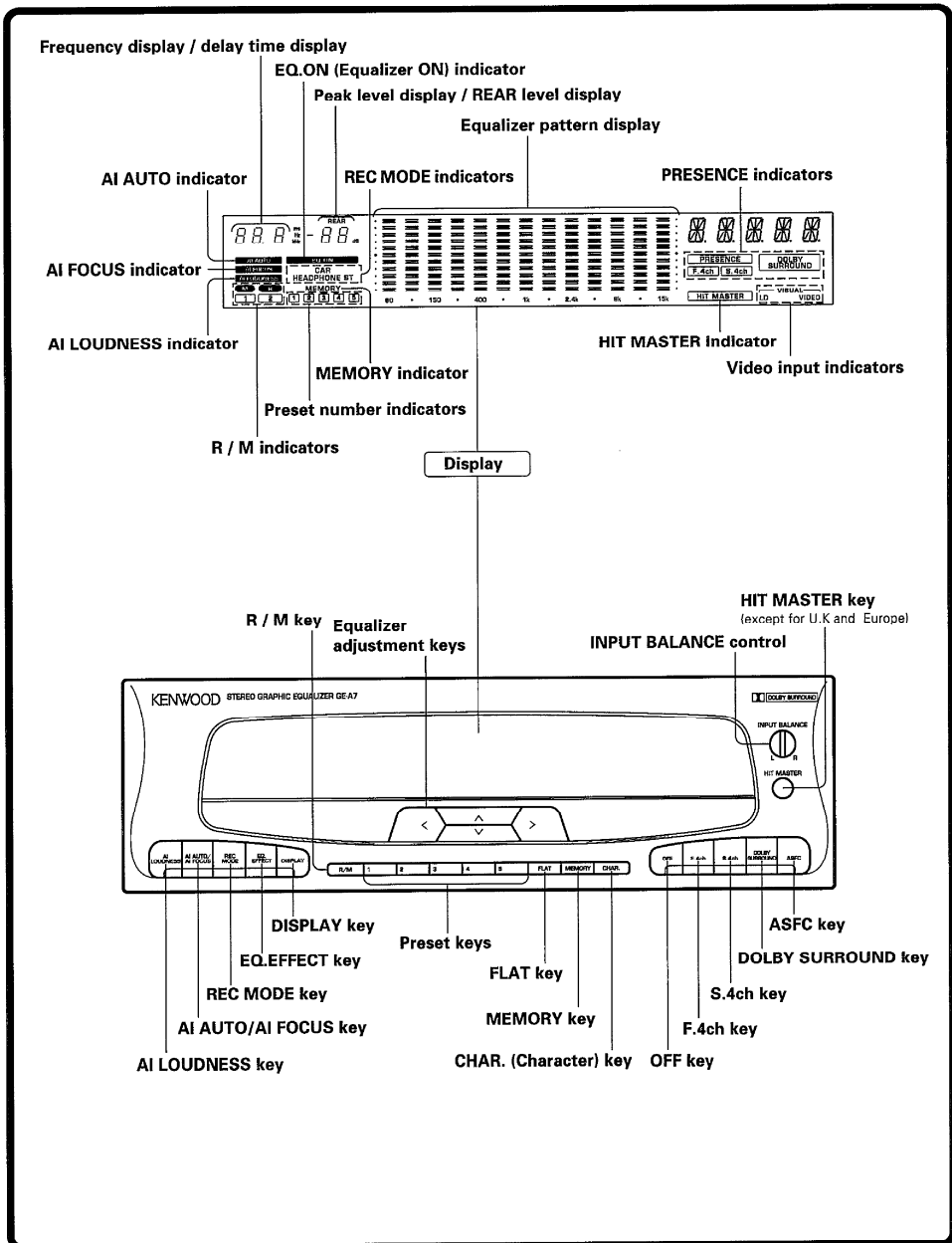

■ CD Player Unit (UD-700: DP-A9)

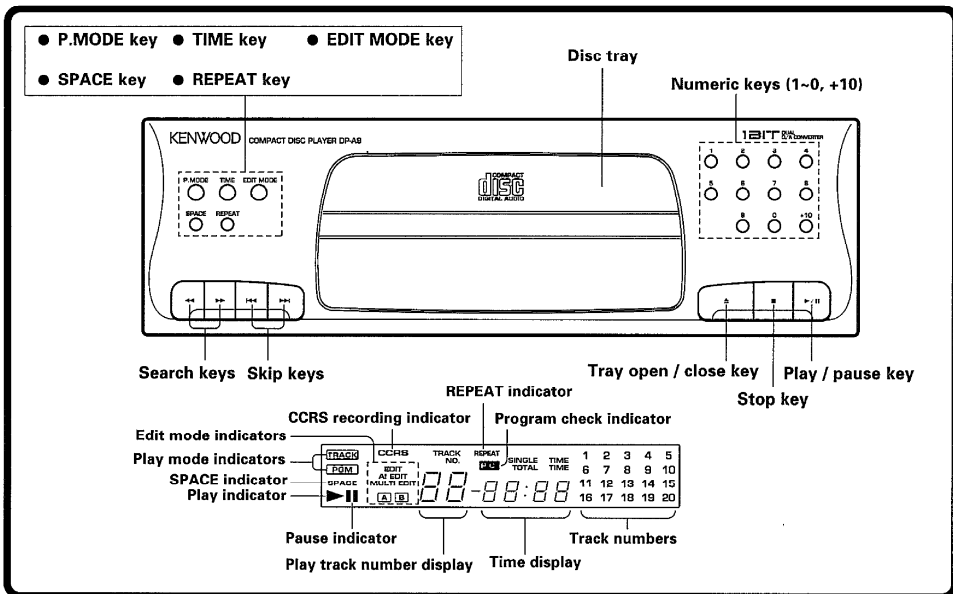

■ CD Player Unit (UD-700M: DP-MA9)

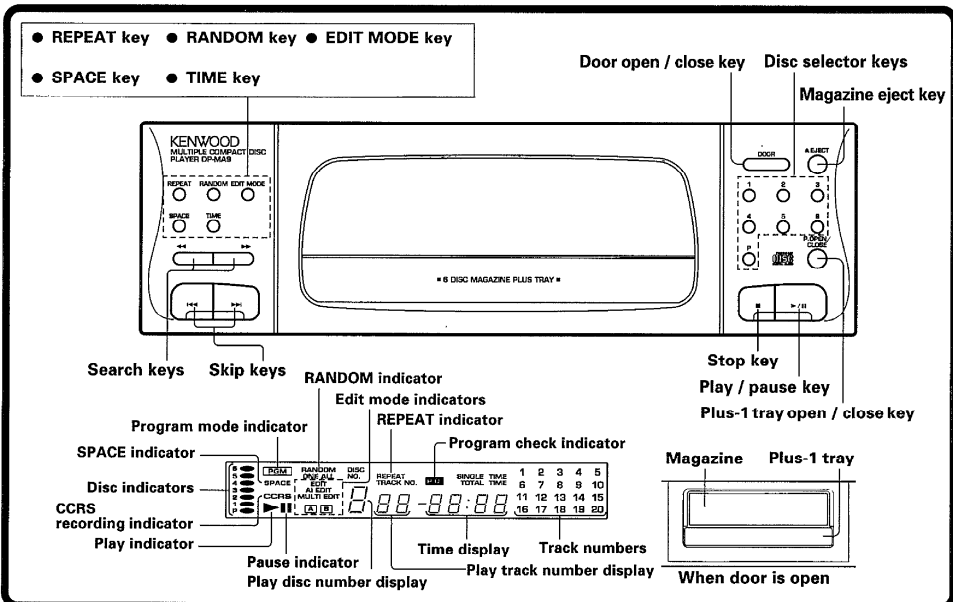

■ Cassette Deck Unit

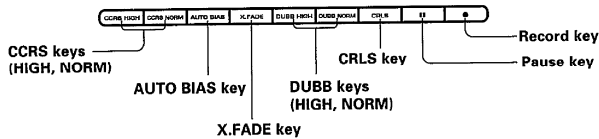
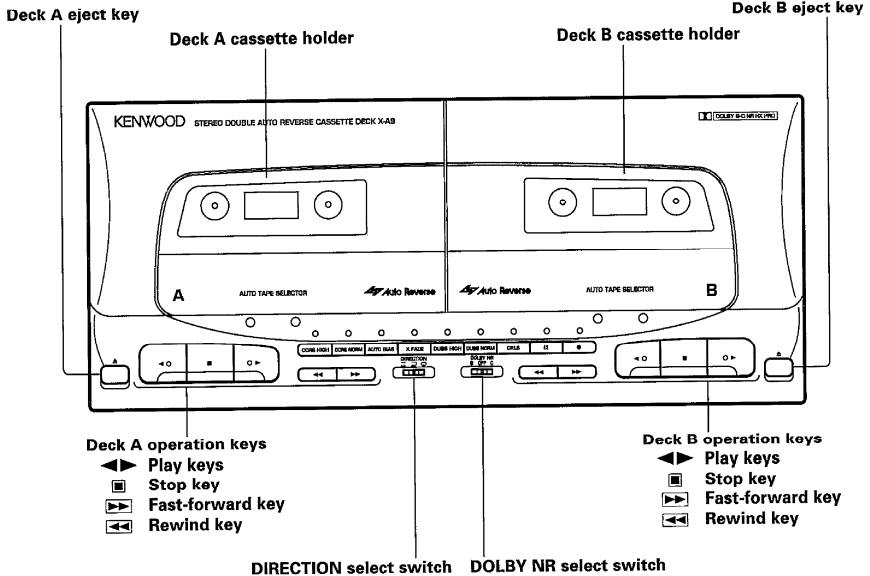

■ Speaker Unit (For U.K. and Europe)

If you live in other area than these, please refer to the separate speaker instruction manual.

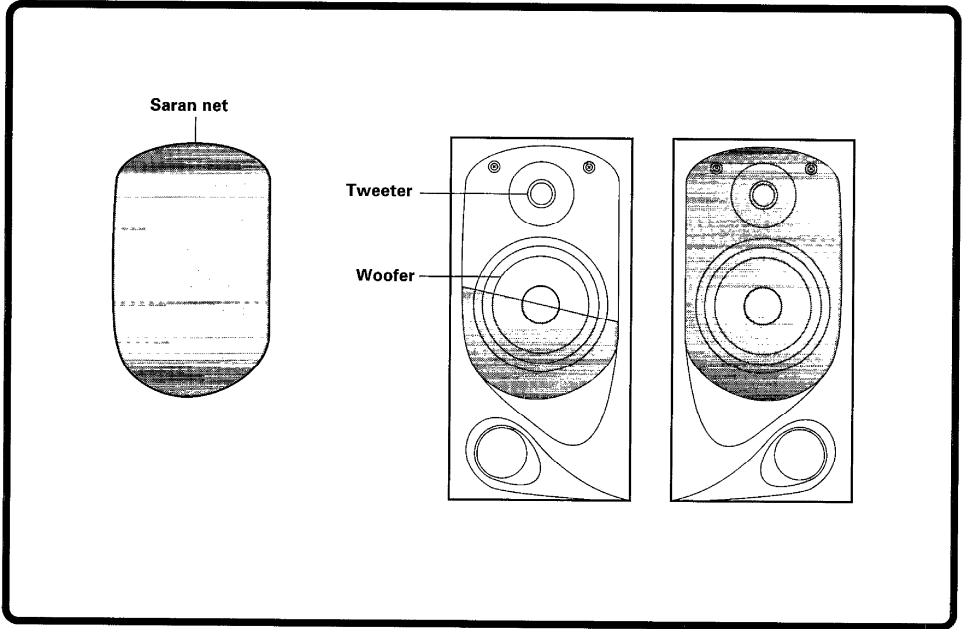

Operation of remote control unit

■ Loading batteries

1 Remove the cover.

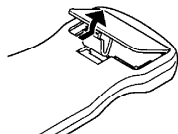

2 Insert batteries.

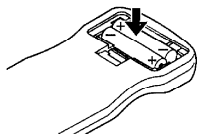

Insert two AAA-size (R03 / UM-4) batteries as indicated by the polarity marking.

3 Close the cover.

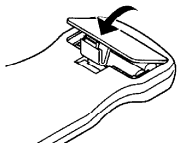

■ Operation procedure

Plug the power cord of the system into an AC wall outlet, and press the **POWER** key on the remote control unit to turn the power on.

When the power is turned on, press the key of the source component to be operated.

- When two operation keys on the remote control unit are pressed successively, press each key securely reserving an interval of more than 1 second for each press.

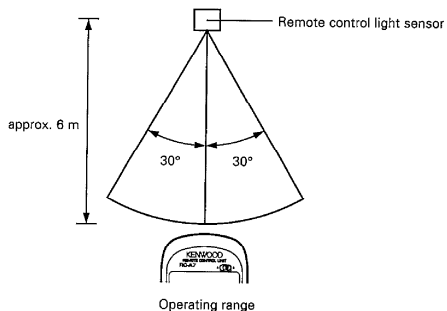

Notes:

- 1 The supplied batteries are intended for use in operation checks. Therefore, their lives may be shorter than ordinary batteries.
- 2 When the remote-controllable distance gets shorter than before, replace both batteries with new ones.
- 3 Malfunction may occur if direct sunlight or the light of a high-frequency lighting fluorescent lamp enters the remote control light sensor. In such a case, change the system installation position to prevent the malfunction.



■ Key Names and Functions

SUPER WOOFER operation keys

To operate the super woofer speaker, set the A/B switch to the A position.
S.W.POWER key, S.W.EFFECT key, S.W.VOL keys.

POWER key

Cassette deck operation keys

To operate deck A, set the A/B switch to the A position. (The  and  keys are invalid in this position.)
To operate deck B, set the A/B switch to the B position.

Numeric keys

When the CD input is selected, these keys can be used as the numeric keys of the CD player.

When the TUNER input is selected, these keys can be used as the numeric keys of the tuner.

Presence control keys

ASFC keys, REAR LEVEL keys, DELAY TIME keys.

Input select keys

VOLUME CONTROL keys

Press to increase or decrease the sound volume. When the keys are operated, the indicator on the VOLUME CONTROL knob of the main unit turns while blinking at a high speed.

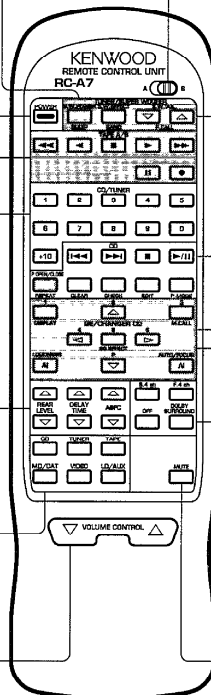

Remote control function A/B selector switch





The keys in the sections marked with  can be used in two ways according to the position of this switch.

- When the function of a key is described in white and brown characters, the brown function is usable in the A position and the white function is usable in the B position.
- Other keys are usable regardless of the A or B position of this switch.

TUNER operation keys

To operate the tuner, set the A/B switch to the B position.
SLEEP key, BAND key, P.CALL key.



CD player operation keys

  keys,  key,  key, CLEAR key, CHECK key, EDIT key, P.MODE key.
When A/B switch is in the A position: P.OPEN/CLOSE key (for CD player equipped with CD disc changer).
When A/B switch is in the B position: REPEAT key

CD changer (DP-MA9) operation keys

To operate the changer-equipped CD player, set the A/B switch to the A position.

Equalizer operation keys

To operate the equalizer, set the A/B switch to the B position.
AI AUTO / AI FOCUS key, AI LOUDNESS key, M.CALL (Memory Call) key, DISPLAY key, EQ.EFFECT keys , , 

Presence effect keys

S.4ch key, F.4ch key,
DOLBY SURROUND key, Presence OFF key.

MUTE key

Model: RC-A7
Infrared control system

Listening to sound

For details, also refer to corresponding pages for each player operations.

For the adjustment of the time displayed on the receiver, please read the next page.

The receiver is equipped with a cooling fan to protect the internal circuits from overheating. Be careful not to place any object close to the fan on the amplifier's rear panel.

Press the POWER key of the receiver.

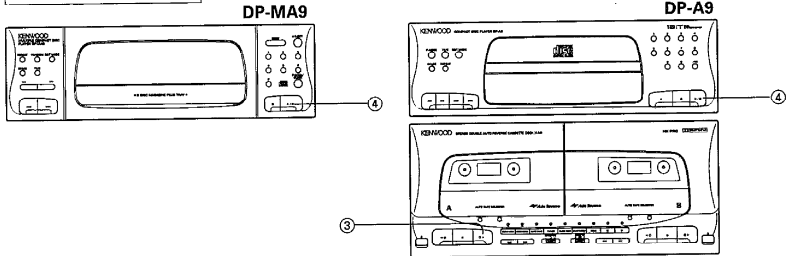

	To listen to a radio broadcast	To listen to a tape	To listen to a CD
1	<p>Select the tuner input. Select a broadcasting band by pressing the BAND key ①.</p>	<p>Insert a tape in Deck A.</p>	<p>Place a CD on the tray.</p>
2	<p>Select a station. Press the TUNING / CHARACTER keys ②.</p>	<p>Play the tape. Press the play key ③.</p>	<p>Play the CD. Press the ▶/II key ④.</p>
3	<p>Adjust the volume.</p> <p>● Turn the VOLUME CONTROL ⑤ for an optimum volume.</p>		

Note:
If sound is not output, check the connections described from page 8 again.

Time adjustment

The receiver incorporates the clock function. Adjust the clock to the exact time, especially when the program timer function is to be used.

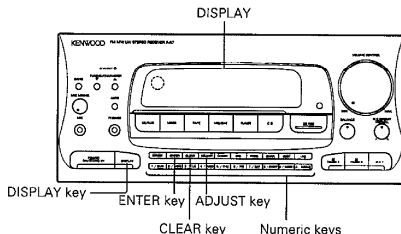

1 Press the ADJUST key.

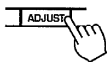

INPUT YEAR
YEAR 1991

2 Input the year using the numeric keys, and press the ENTER key.

To input 1992: press **1**, **9**, **9**, **2**.



YEAR 1992
INPUT DATE

- If you commit a mistake in the input of numeric keys, press the **[CLEAR]** key, and re-start the input from the beginning.

3 Input the month then the day, and press the ENTER key.

To input March 7: press **0**, **3**, **0**, **7**.

To input December 30: press **1**, **2**, **3**, **0**.



DATE 0101
DATE 1230
INPUT TIME

- If you commit a mistake in the input of numeric keys, press the **[CLEAR]** key, and re-start the input from the beginning.

4 Input the time of the day.

To input 9:05AM: press **0**, **9**, **0**, **5**.

To input 4:50PM: press **1**, **6**, **5**, **0**.

Use the 24-hour system.

TIME 0000
TIME 1650

- If you commit a mistake in the input of numeric keys, press the **[CLEAR]** key, and re-start the input from the beginning.

5 Press the ENTER key.



TIME 1650
END

- For correct time adjustment, it is recommended to press the **[ENTER]** key at the same time as a time announcement.

Clock starts to work.

Note:

The time display blinks after a power failure or when the power cord was unplugged from the power outlet. In this case, adjust the time again.

Displayed contents and DISPLAY key

Every time the **[DISPLAY]** key is pressed while a radio station is received, the displayed contents is switched to the frequency to the station name, present time, and date (month and day). When a key associated with tuning is pressed while the date or time is being displayed, it is switched to the frequency display, and returns to previous content in a few seconds. When the **[DISPLAY]** key is pressed while the power is OFF, the displayed content is switched alternately between the date and time.

Audio adjustment

Press the POWER key of the receiver.

- The POWER key on the receiver can switch on / off the powers of main system.



Remote control unit

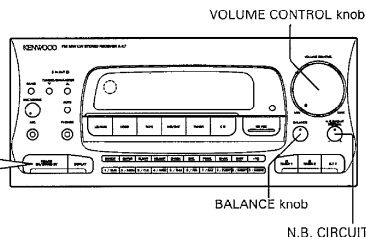

■ Adjusting the volume

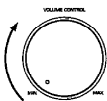

Remote control unit

- When the volume is adjusted from the remote control unit, the point indicator on the VOLUME CONTROL knob blinks and rotates together with the control knob.

To mute sound temporarily

Remote control unit only

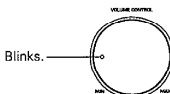

- Pressing the key again resumes the previous volume.

■ Adjusting the left and right volume balance

BALANCE



To decrease right speaker volume

To decrease left speaker volume

■ Compensation of bass sound



N.B. CIRCUIT: Natural Bass Circuit

- Usually set the switch to the NORMAL position.
- Adjust to obtain a more natural bass sound.

STAND BY mode of POWER switch

When the power cord of this system is plugged into an AC outlet, the display lights up regardless of the ON / OFF setting of the POWER switch. This indicates that a small amount of current is being supplied to the unit to back up the memory contents. This mode is referred to as the Stand By mode. While the display is lit, the power of the system can be switched ON / OFF from the remote control unit.

Automatic play operation function associated with input selector keys of receiver

The automatic play operation allows to start playing the selected input source by simply pressing the input selector key (TAPE, TUNER, CD). It also allows to select a correct input selector key on the receiver by simply starting playback on the desired input source component.

The same operation is also possible with the input selector keys on the remote control unit.

The input source selected at the moment the power is switched ON is the last source (TUNER, CD, etc.) selected before switching the power OFF.

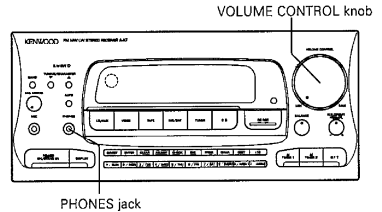

■ Listening through headphones

- 1 Insert the headphone plug into the headphones jack.



- Sound from all speakers is turned off.

- 2 Adjust the volume.

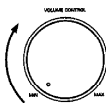

Remote control unit

- Be sure to minimize the volume before unplugging the headphone plug.

■ Operation of super woofer key

The connection of super woofer, described on page 11, must be completed before proceeding to the following.

- 1 Press the S.W. EFFECT key.



Remote control unit



Receiver

- The receiver's "S.W.OUT" indicator lights.

- 2 Adjust the super woofer volume.

Adjust the **VOLUME** control on the remote control unit or the super woofer.

- Once the super woofer volume is set, it is varied with respect to the master volume by varying the **VOLUME CONTROL**.

CD REC key

Refer to "Operation of CD REC key" on page 57.

Connection of microphone (Except for U.S.A., Canada, U.K. and Europe)

Refer to "Simple Karaoke singing entertainment" on page 66.

Reception of radio broadcast

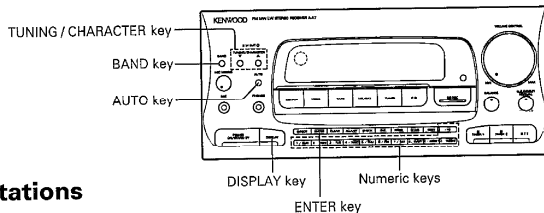

■ Receiving broadcast stations and storing them in memory (preset operation)

1 Display the frequency display.

- Every time the [DISPLAY] key is pressed, the displayed contents are switched in order or Frequency → Broadcast station name → Present time → Date (month & day).

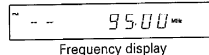

Frequency display

2 Select the broadcast band.

- The frequency is displayed for a few seconds when a key associated with tuning is pressed.



The bands are switched as follows every time the [BAND] key is pressed.

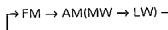

3 Select the tuning mode.

- Normally, select the auto mode (with AUTO lighted).

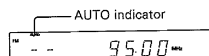

Press the key to select the auto (AUTO lighted) or manual (not lighted) mode.

4 Tune the desired station.

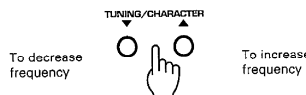

- The TUNED indicator lights up when a station is received.
- Use manual tuning mode when the radio wave is weak and noisy. At this time, the stereo FM broadcast is received in monaural mode.

Auto tuning mode	Manual tuning mode
Press once. (Tuning stops automatically when a station is received.)	Press repeatedly, or press and hold, until the desired station is received.

5 Store the station in preset memory.

- Press the ENTER key.

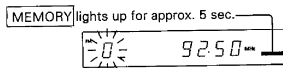

- Proceed to step ② before [MEMORY] stops lighting.

- Press the desired numeric key.



Examples of input

To select preset No. 15: [+10] 15

To select preset No. 20: [+10] [+10] 0

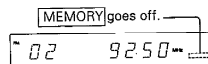

- When a station has previously been preset under the numeric key pressed, the newly preset station replaces the previous station.
- When preset is to be continued, repeat steps 2 to 5.
- Up to 20 broadcast stations can be preset regardless of the broadcasting bands.

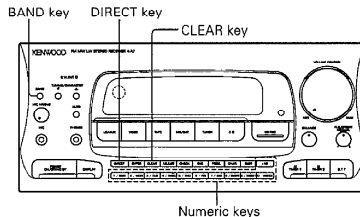
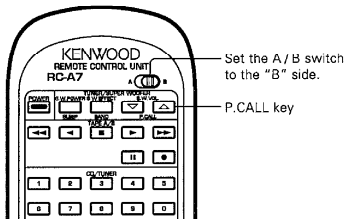

■ Receiving a preset station

Select the desired station.

Press the numeric key.



- The frequency of the tuned station is displayed.

■ Listening to all preset stations in sequence (PRESET CALL)

Remote Control unit only

Press the P.CALL key.



- Every time (UP) is pressed, the preset stations are received in order of 1 → 2 19 → 20 → 1.....
- Every time (DOWN) is pressed, the preset stations are received in order of 20 → 19 2 → 1 → 20
- When a key is held depressed, the preset stations are received in sequence at 0.5-second intervals. The station being received when the key is released will continue to be received.

■ Direct tuning of radio stations

If you know the frequency of the desired station, it can be received directly by inputting the frequency using the numeric keys.

1 Select the broadcast band.

One of FM or AM (MW / LW).



2 Press the DIRECT key.



3 Input the frequency to be tuned by pressing the numeric keys.



Example of input

Desired station	Order of pressing numeric keys
FM 90 MHz	, , (100 kHz space) , , , (50 kHz space)
FM 102.5 MHz	, , , (100 kHz space) , , , , (50 kHz space)
AM (MW) 810 kHz	, (10 kHz space) , , (9 kHz space)
AM (MW) 1280 kHz	, , (10 kHz space) , , , (9 kHz space)

- If you commit a mistake in the input of numeric keys, press the **CLEAR** key, and re-start the input from the beginning.

■ Displaying station names

Station names composed of up to four digits of characters and / or symbols can be displayed on the receiver display. Example: To receive FM 93.4 MHz, input its name with characters "CBE", and preset them under numeric key [3].

1 Receive FM 93.4MHz, and enter the character input mode.

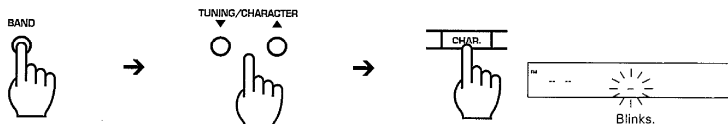

2 Select the characters to be displayed with that station.

① Display the desired character.

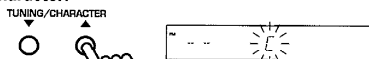

② Establish the selection.

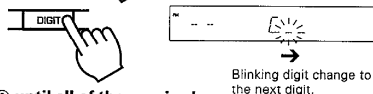

③ Repeat steps ① and ② until all of the required characters have been input.

- To select "C", press the UP segment three times.
- To insert a space, simply press the [DIGIT] key.

Types of characters that can be input

After having pressed the [CHAR.] key, press the [TUNING / CHARACTER] key to display the characters available.

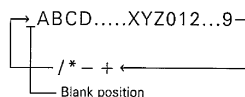

3 End the character input.

The character input also terminates automatically when fourth character has been input.

Press the [CHAR.] key to terminate character input with three characters or less.

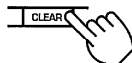
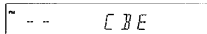

In case you commit an input mistake, press the [CLEAR] key and re-start from the first digit.

4 Preset them under key [3].

① Press the ENTER key.

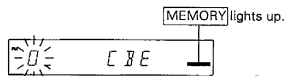
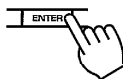

② Press numeric key [3].

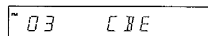
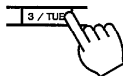

Press while [MEMORY] is lighted.

Example: When a station name is displayed with the [DISPLAY] key.

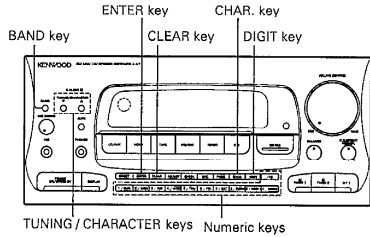

■ Changing a station name

Example: To change station name "FHN8" preset with AM (MW)
 810 kHz frequency under numeric key [2] to "FEN".

1 Receive preset station of [2] by preset tuning, and enter the character input stand-by mode.

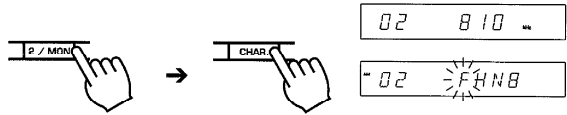

2 Move the blinking digit to the second digit.



3 Select "E" with TUNING / CHARACTER key.



4 Move the blinking digit by two digits.

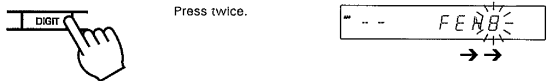

5 Select the blank with the TUNING / CHARACTER key.



- The character input terminates automatically when fourth character has been input.

6 Preset the new name under numeric key [2].

① Press the ENTER key.

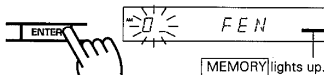

② Press numeric key [2].

Press while MEMORY is lighted.

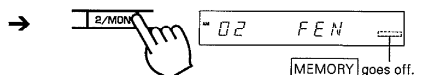

Example: When a station name is displayed with the [DISPLAY] key.

Operation of graphic equalizer

This system features a sophisticated graphic equalizer which allows fine adjustment of frequency bands. It is possible to compensate for the acoustics of the listening room as well as to enjoy music with optimum sound thanks to the AI (Artificial Intelligence) features as described below.

1. DEMO (Demonstration)

Displays various equalizer curves visually in sequence together with the actual sound effect of each curve as audible demonstration.

2. AI-AUTO (for normal CD playback only)

Checks the contents recorded on a CD automatically, and sets the optimum equalizer pattern according to the CD.

3. AI-FOCUS (for CD playback in presence modes only)

With this function, the recorded contents of CD is checked with respect to the selected presence mode, and the optimum ASFC value and equalizer curve are set automatically to create a live atmosphere of presence.

4. AI-LOUDNESS

The lowest and highest frequencies are enhanced according to the current volume setting. The function is effective when listening at low volume.

5. REC MODE (Curves for use in recording)

A "CAR" curve is provided for recording tapes to be played on a car stereo, and a "HEADPHONE ST" curve is provided for recording tapes to be played on a headphone stereo.

6. REFERENCE / MANUAL modes

REFERENCE: Ten exemplary patterns have been preset at the factory.

MANUAL: Five preset patterns have been factory-preset for this mode. In this mode, it is also possible to preset (assign) equalizer patterns created by the user in place of the factory presets.

7. AI-LINK

When The presence mode is selected, optimum equalizer curve for this mode is selected automatically to enhance the presence effect.

8. CHARACTER

In the spectrum analyzer display mode, the level of the music being played and changes of frequency distribution with four different patterns are displayed.

SPE.ANA	1: NORMAL	Normal spectrum analyzer display
	2: SHOWER	Reversed normal spectrum analyzer display with the normal peak hold levels display
	3: HORIZONTAL	Displays right and left levels with the frequency band in vertical axis and level in horizontal axis.
	4: SEE-THROUGH	Displays peak hold levels only.

DOLBY SURROUND and PRESENCE keys

Refer to "Presence effect" pages 67.

HIT MASTER key (Except for U.K. and Europe)

Refer to "Simple Karaoke singing entertainment" on page 66.

AI: Artificial Intelligence.

The AI is capable of adjusting the tone automatically according to the source and music categories.

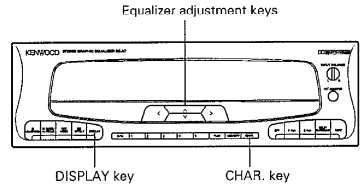

Contents of display

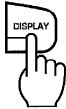

The display mode changes every time the **[DISPLAY]** key is pressed.

Spectrum analyzer display

Displays the frequency distribution of the source being played to allow understanding at a glance. The peak value of the varying level of each frequency range is held and displayed for about 0.5 seconds.

Graphic equalizer display

Shows how each frequency range is compensated. The graphic equalizer display also appears for about 5 seconds, even while the unit is in the spectrum analyzer display mode, when one of the following operations is performed.

1. Switching power ON.
2. An operation key associated with an equalizer operation is pressed.

Level display

This display shows the peak level values of the frequency bands digitally. To check the peak level of a frequency band, select the frequency band with the equalizer control keys.

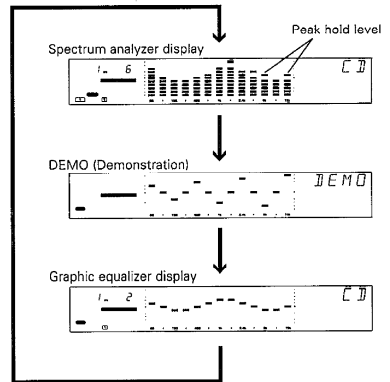

Character display

Press the **[CHAR.]** key in the spectrum analyzer display.



The display mode changes every time the **[CHAR.]** key is pressed.

SEE-THROUGH



NORMAL

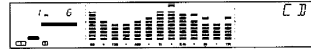

SHOWER



HORIZONTAL

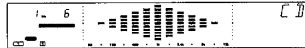

■ Demonstration procedure

This feature makes it possible to check the equalizer effects both visually and audibly.

- ① Play the source.
- ② Select DEMO with the DISPLAY key.



Demonstration is repeated in the following cycle.

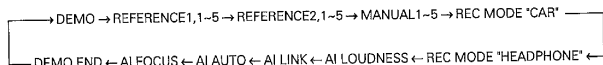

- Press the **DISPLAY** key to stop demonstration.
- During AI LINK demonstration, the surround mode also changes.
- When demonstration is started in the surround mode, the surround mode will be turned OFF in the middle of demonstration.

■ Operation of AI AUTO (for normal CD playback only)

By pressing the AI AUTO / AI FOCUS key while the presence modes are OFF, the equalizer curve suited to the contents of the CD is set automatically.

1 Place a disc in the CD player.

TRACK lights up. Track Nos. in disc are indicated.

- With the UD-700M system, select the desired disc.

Verify that the presence indicators (F.4ch, S.4ch) are extinguished.

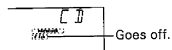

2 Press the AI AUTO / AI FOCUS key.

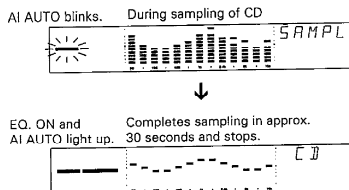
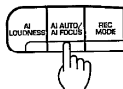

- Wait for about 30 seconds until EQ.ON and AI AUTO light up.

The playback starts automatically.

Note:

During the AI AUTO setting process, keys other than the **AI AUTO / AI FOCUS** key do not function.

To cancel AI AUTO

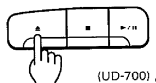

(UD-700)

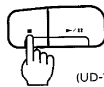

(UD-700M)

CD player



AI AUTO goes off.

- The equalizer curve becomes flat.
- If it is canceled during AI AUTO setting operation, the last pattern selected before is displayed.

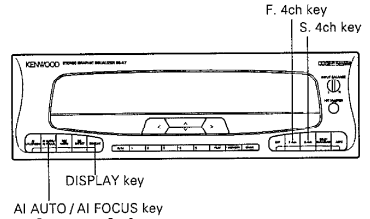

■ Operation of AI FOCUS (for CD presence modes only)

The optimum ASFC value and equalizer curve for the contents of the CD are set automatically by simply pressing the AI AUTO / AI FOCUS key after selecting the presence mode.

1 Place a disc in the CD player.

"TRACK" lights. Check indicators. The available track numbers appear on the display.

- With the UD-700M system, select the desired disc.

2 Select the desired presence mode.

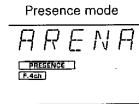
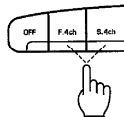

- For details regarding presence mode, see pages 67~70.

3 Press the AI AUTO / AI FOCUS key.

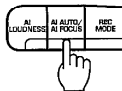

AI FOCUS blinks. During sampling of CD

EQ.ON and AI FOCUS light up. Completes sampling in approx. 30 seconds and stops.

- Wait for about 30 seconds until AI FOCUS lights up.
- The ASFC value and equalizer curve are set according to the selected presence mode.
- If the presence mode is changed after the AI FOCUS setting has been made, the optimum ASFC value and equalizer curve for the new presence mode will be set automatically.

The playback starts automatically.

Note:
During the AI FOCUS setting process, keys other than the AI AUTO / AI FOCUS key do not function.

To cancel AI FOCUS

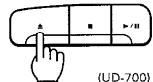

(UD-700)

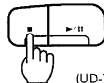

(UD-700M)

CD player

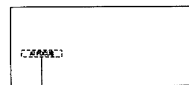

AI FOCUS goes off.

- If it is canceled during AI FOCUS setting operation, the last pattern selected before is displayed.
- If it is canceled after AI FOCUS setting operation, the curve becomes flat.

Operation of graphic equalizer

■ Operation of AI LOUDNESS control

This feature compensates automatically the lack of low and high frequencies felt when listening at low volume.

To activate the AI LOUDNESS effect

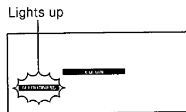

- The equalizer pattern being selected will be combined with the loudness compensation pattern which corresponds to the sound volume.
- When the CAR or HEADPHONE ST mode is selected with the REC MODE key, the AI LOUDNESS cannot be operated.
- To record with optional equipment, be sure to cancel the AI LOUDNESS function.

To cancel AI LOUDNESS

Press the key again.

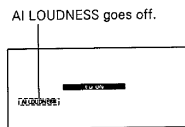

- The previous equalizer pattern resumes.

■ How to use the REC MODE key

Use the following function when recording tapes to be played on a car stereo or headphone stereo.

1 Play a music source.

2 Set to the equalizer mode.

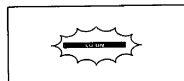

3 Select a desired curve.

Use the AI AUTO curve or select a desired curve from patterns R1-1 to 5, R2-1 to 5 and M1 to M5. Also refer to page 35.

4 Select a REC MODE.

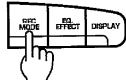

Each press switches the modes.

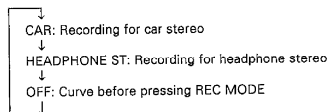

- The combination synthesizing the current equalizer curve being selected and the recording curve for car stereo or headphone stereo is applied to the music.
- AI LOUDNESS is canceled automatically when a REC MODE is selected.
- Select OFF (indicator extinguished) when the unit is used as an ordinary equalizer or for general recording for other tapes than those played on a car stereo or a headphone stereo.

5 Start recording.

Refer to page 54.

To cancel the REC MODE

Press the key to select OFF (indicator extinguished).

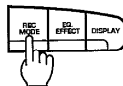

- The display shows the curve before synthesis again.

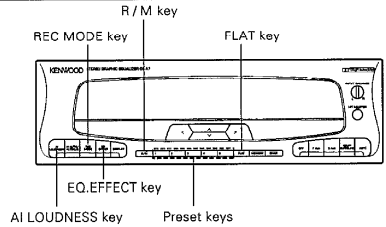
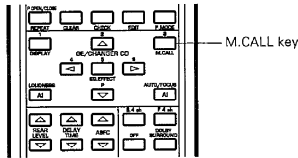

■ Operation of REFERENCE / MANUAL feature

This feature allows to recall one of fifteen preset equalizer patterns in a simple manner.

1 Play a music source.

2 Press the EQ.EFFECT key.



3 Select an equalizer pattern.

① Set to MANUAL, REFERENCE 1 or 2.

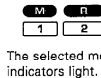

② Press the key for the desired pattern.
(Refer to the equalizer pattern list on page 35.)



Example when "3" is selected in the MANUAL mode.

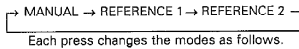

Remote-controlled selection is also possible.

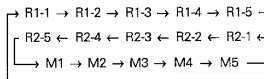

Patterns are switched every time the M.CALL key is pressed.



Example when "4" is selected in the REFERENCE 1 mode.

To cancel the equalizer effect



- The pattern being displayed remains the same.

How to use the FLAT key

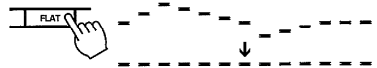

- Pressing the FLAT key makes the displayed curve flat.
- As the loudness is operated in the AI LOUDNESS mode, the display does not become flat.

Operation of graphic equalizer

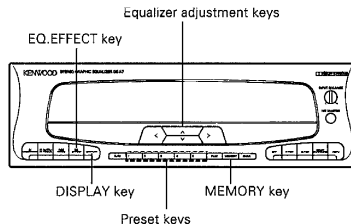

■ How to store desired pattern (M1 ~ M5)

1 Creation of equalizer patterns

- ① Play a music source and press the EQ.EFFECT key.



- ② Select the graphic equalizer display.

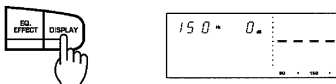

- ③ Select the frequency band to be adjusted.

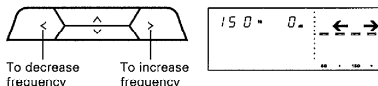

- ④ Adjust its level.

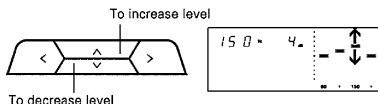

- ⑤ For each frequency band to be adjusted, repeat steps ③ and ④ above.

2 Create a desired equalizer pattern.

- ① Press the MEMORY key.

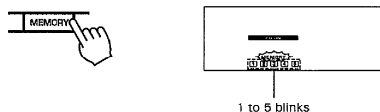

- ② Press one of the preset keys.

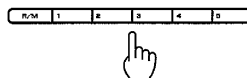

Press while [MEMORY] is lighted up.

- Pattern is preset under the number of the numeric key pressed.
- Up to five patterns can be preset in the same manner.
- If you press a preset key which contains a previously stored pattern, the previous pattern is replaced by the new pattern.
- In the AI LOUDNESS ON mode, the pattern cannot be stored.

To return to the initial pattern (factory-preset patterns M1 to M5) by clearing the user-preset pattern.

Press the preset key where the pattern to be cleared is preset for more than 5 seconds.

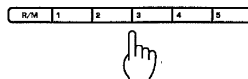

■ Equalizer pattern list

15 kinds of preset equalizer patterns can be recalled easily. Select the optimum pattern.

Preset (R1-1 to 5) equalizer patterns REFERENCE 1 "Basic"	
R1-1	(Popular, Fusion) Makes the fusion music or the vocal of pop music distinct while providing optimum compensation for the low and high frequencies.
R1-2	(Rock) Makes the vocal of rock music distinct while providing optimum compensation for the low and high frequencies.
R1-3	(Jazz) Makes the midrange frequencies in jazz music, including the vocal, piano and sax distinct, while providing optimum compensation for the low and high frequencies.
R1-4	(Classic) Provides a proper, polished classical music by compensating the low, midrange and high frequencies.
R1-5	(Movie) Makes the dialogues distinct while providing optimum compensation for the low and high frequencies.
Preset (R2-1 to 5) equalizer patterns REFERENCE 2 "Scale"	
R2-1	(Popular, Fusion) Reproduces crisp sound with distinct vocal and enhanced low and high frequencies.
R2-2	(Rock) Reproduces powerful sound with distinct vocal and enhanced low and high frequencies of the bass, guitar and drums.
R2-3	(Jazz) Makes the vocal, piano and sax more distinct while providing powerful, full bass and drum sound by enhancing the low and high frequencies.
R2-4	(Classic) Reproduces dynamic sound with a full scale through heavy low, powerful midrange and unrestrained high frequencies.
R2-5	(Movie) Makes the dialogues distinct while enhancing the low and high frequencies for a powerful sound with full atmosphere of presence.

Preset (M1 to M5) equalizer patterns MANUAL "Clear"	
User-set curves can be stored in this mode.	
M1	(Popular, Fusion) Makes the fusion music or the vocal of pop music distinct while making the the low and high frequencies clear by enhancing them.
M2	(Rock) Makes the vocal of rock music distinct and enhanced the low and high frequencies.
M3	(Jazz) Makes the jazz vocal and drums distinct, while making the low and high frequencies clear by enhancing them.
M4	(Classic) Attenuates the low frequencies and enhanced the midrange and high frequencies to provide wind instruments and vocals with unrestrained sound.
M5	(Movie) Makes the dialogues distinct by attenuating the low and high frequencies.

■ Functions of graphic equalizer

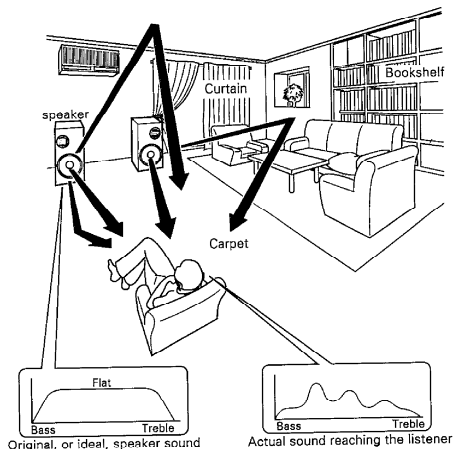

Compensation for the audio characteristics of the listening room

The listening room may contain several objects. Some of them reflect sound and some absorb sound, thus the sound reaching your ears is considerably affected by these objects.

In such cases, the graphic equalizer can be used to adjust the frequency response of the room for a flat response from low to high frequencies.

- Low frequencies are absorbed by beds, chairs, etc.
- High frequencies are absorbed by curtains, screens, etc.
- The room structure can cause the low frequencies to be unclear, or the sound level to increase or decrease depending on the frequency.

Adjustment of sound to your individual taste

When the reproduced sound contains several musical instruments and voices, the graphic equalizer allows you to enhance or attenuate the sound of specific instruments or voices.

Sound equalization

Super bass range (60 Hz)

When this control is moved up, the bass instrument (double bass, bass drums, or pipe organ, etc.) sound is increased.

When the super bass sound is boomy, move this control down.

Bass range (150 Hz)

Usually, the listening room resonance frequency is in this range. To eliminate bass resonance, move this control down.

Mid-bass range (400 Hz)

This range is the basis of music. Whether the sound is rich or not, depends on this range. When the playback sound is not so good, move this control up.

Mid range (1 kHz)

When this control is moved up or down, the baritone or soprano voice is emphasized / de-emphasized. This range is related to the "presence" of music.

Mid-high range (2.4 kHz)

This range is related to stimulous and metallic sound. When this range is well compensated, vivid sound can be obtained.

High range (6 kHz)

This frequency range is related to the hardness of the sound. When this control is moved up, strings or brass instruments, such as flutes or piccolos, are emphasized. When the control is moved down, the sound will be more soothing.

Super high range (15 kHz)

This frequency range is related to the details of the music. When this control is moved up, super high frequency instruments, such as triangles or cymbals, are emphasized, resulting in wide sound and echoes.

Playing CDs (UD-700)

The description on pages 37 to 41 deals with the operation procedure of the CD player unit designed exclusively for the UD-700. For the operation procedure of the UD-700M (CD player with disc changer), please refer to pages 42 to 49.

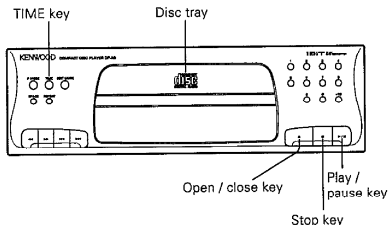

■ Playing a CD from the beginning

1 Select the CD source with the input selector of the receiver.

2 Load a CD.

① Open the disc tray.

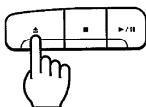

② Place a disc on the tray.

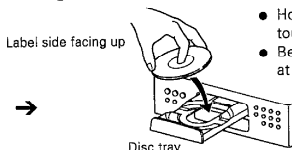

③ Close the tray.

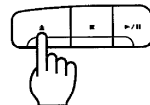

- Hold the disc taking care not touch the side to be played.
- Be sure to place only one CD at a time.



3 Start playback.

- In a few seconds, playback starts from track No. 1.

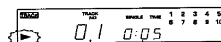
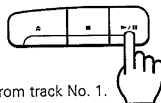

To pause CD play

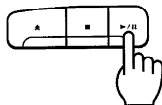

To resume playback, press the [▶/II] key again.

To stop CD play

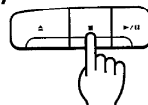

TIME key

Press the [TIME] key when you want to check the elapsed time and remaining time of the track being played. Every time the [TIME] key is pressed, the displayed time changes as shown below.

The time information display may not appear when playing a CD containing 44 or more tracks.

In such a case, the display (remaining SINGLE TIME) will show "--:--".

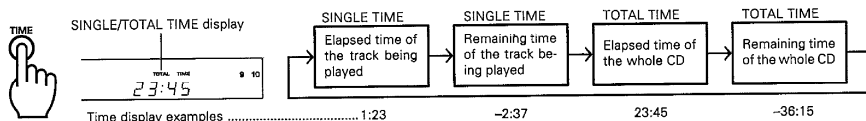

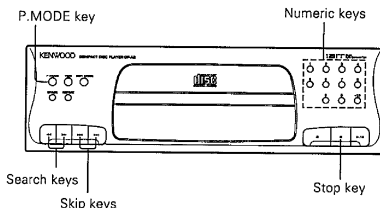
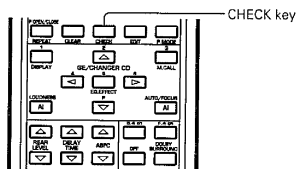

■ Listening from the desired track

Select with the skip key.

Press one of the skip keys according to which direction to skip.



- The tunes are skipped in the direction of the key and the play starts at the beginning of the selected tune.
- When the key is pressed once during play, the track starts again from the beginning.

Select with the search key.

Press the forward or reverse search key according to the direction to search.



- The fast forward or reverse speed increases as the key is held depressed.
- The track will start to play from where you release the key.

Select with the numeric key.

1 Ensure that the CD player is in the TRACK mode.

- If the **PGM** indicators is lighted, press the **P. MODE** key.

2 Select the desired track.

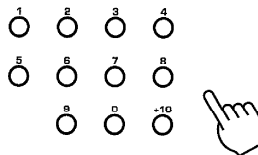

Examples of input

Track No. 23: **[+10] [+10] [3]**

Track No. 40: **[+10] [+10] [+10] [+10] [0]**

- Play starts from the selected tune and after.

Notes:

1. If a track No. which is not present on the CD is selected while the tray is open, the last track on the CD will be played.
2. Such a selection is not accepted after the tray has been closed or playback has started.

■ Playing desired tracks in desired order (PGM mode)

1 Enter the PGM mode.

Press the P. MODE key.

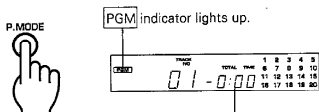

The SINGLE TIME display changes to the TOTAL TIME display.

2 Program desired tracks in desired order.

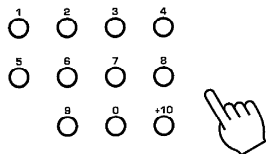

Example

To program track Nos. 2, 5 and 25: [2] [5] [+10] [+10] [5]

Blinks.

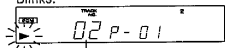

The number of the selected track in the program (P.No.) is displayed for a few seconds.

Track No. ↓

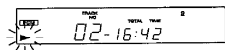

The total time of the selected track will be displayed.

- Up to 20 tunes can be programmed. When the 21 or more tunes are selected, FULL is displayed.
- If you made a mistake, press the [CLEAR] key and select the correct track.
- Tracks can also be programmed by reading the disc label while the disc tray is open.
- If a tune number larger than 43 (44 and subsequent) is selected, the remaining time of the whole CD disc will not be displayed.

3 Start playback.

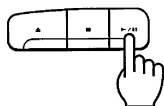

- Tracks are played in the order they are programmed (P.No.).
- If one of the skip keys ([▶] or [◀]) is pressed during programmed playback, the track being played is skipped in the forward or reverse direction.

To check the programmed order

Remote control unit only

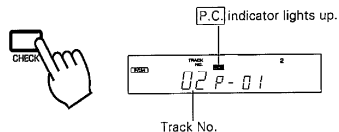

Track No.

- Every time the [CHECK] key is pressed, the track No. and the order it was programmed (P.No.) are displayed in the order of programming.
- The previous display will resume in a few seconds.

To resume normal playback

P.MODE



- The playback in the order of the track Nos. on CD will start after the track being played.

To stop programmed playback

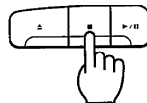

To check the time of each track on the disc.

In the program mode, when the disc is stopped, the time of each track on the disc can be checked by pressing the skip keys [▶] , [◀] .

- The previous display will resume in a few seconds.

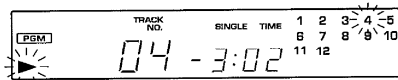

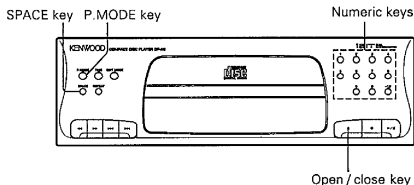
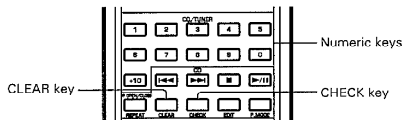

■ To add a track to the program

Press the key(s) for the track No. to be added.

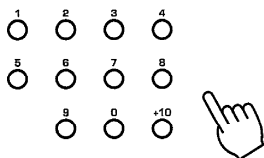

■ To clear tracks from the program

Clearing from the last track

Remote control unit only



- Every time the key is pressed, tracks are cleared from the last track in order.

■ To change a track in the program

Remote control unit only

1 Press the CHECK key.

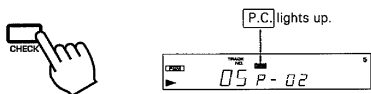

Press repeatedly until the program No. to be changed is displayed.

2 Press the key(s) to input the track No. to replace the previous one.

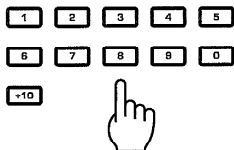

Press while the [P.C.] indicator is lighted.

- The track being played cannot be changed.

Clearing the whole of program

Press either key.



Auto-Space function

During playback in the program mode, when the [SPACE] key is pressed, a space of about 4 seconds is reserved automatically between the programmed tracks. This function is provided to facilitate the DPSS function of the cassette deck. However, such a space could also be reserved in case the sound of two tracks are continued for example with some classic music and live recordings.



- The total time is displayed including the time of the space.
- To cancel Auto-Space function, press the [SPACE] key again.

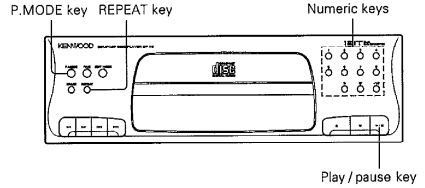

■ Repeated playback

Repeated playback of programmed tracks.

1 Enter the PGM mode.

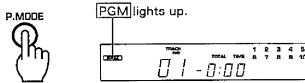

2 Select the desired track(s).

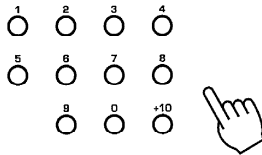

- All of the selected tracks will be played repeatedly.
- If only one track is selected, that track will be played repeatedly.

3 Press the REPEAT key.

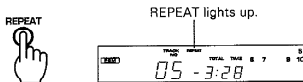

4 Start playback.

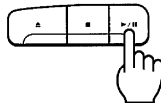

Repeated playback of the whole CD.

1 Enter the TRACK mode.

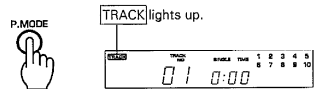

2 Press the REPEAT key.

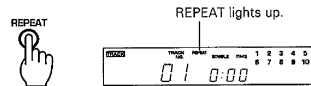

3 Start playback.

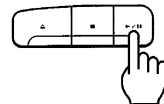

To resume normal playback

Press the REPEAT key again.



REPEAT goes off.

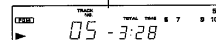

- The playback will be resumed under the CD player mode set before the repeat.

Playing CDs (UD-700M)

The following description deals with the operation procedure of the UD-700M (CD player with disc changer). For the CD player unit of the UD-700 (normal CD player), please refer to pages 37 to 41.

■ Loading a disc into the magazine

1 Pull out the disc tray.

① While pressing in on the lock button

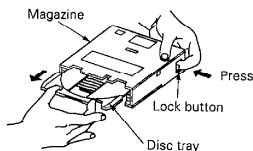

② Pull out the disc tray.

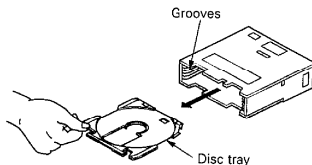

2 Place a disc on the disc tray.

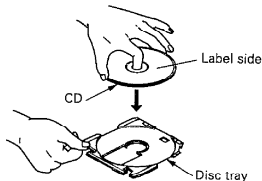

- Commercially-available CD single (8 cm) disc adapters cannot be used in this system. To play CD single (8 cm) discs, use the optional CDM-608 CD single magazine.

3 Insert the disc tray into the magazine.

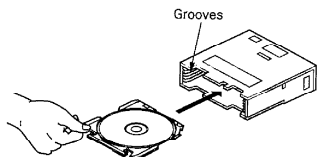

Align the tray with the corresponding left and right grooves and insert horizontally into the magazine.

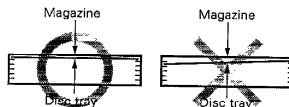

- Be sure to place each disc on a disc tray before inserting into the magazine.
- Even when loading fewer than six discs, make sure there are six disc trays inserted in the magazine during use.
- Always hold the magazine level when carrying.

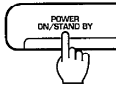

Be sure to turn on the receiver before performing the following operations.

■ Loading a magazine

1 Open the door.



2 Insert the magazine.

①

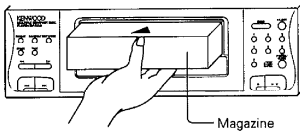

②

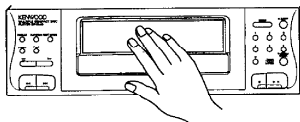

Press in until it locks in place with a click.

3 Close the door.



■ Removing a magazine

1 Open the door.



- By pressing the eject key, the door can also be opened and the magazine ejected.

2 Remove the magazine.

① Press the eject key.

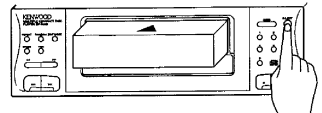

② Pull out the magazine.

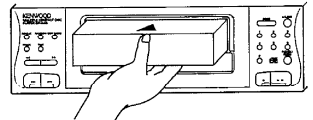

Hold the magazine in the center.

3 Close the door.



■ Loading a disc in the plus-1 tray

① Open the plus-1 tray.



② Place a disc on the tray.

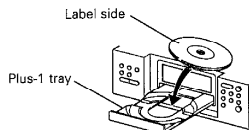

③ Close the plus-1 tray.



- The door opens and the plus-1 tray comes out.

- The plus-1 tray retracts into the unit and the door closes.

Playing CDs (UD-700M)

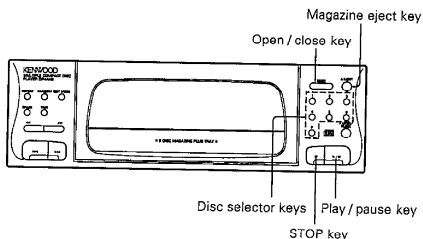

■ Playing a CD from the beginning

1 Place a disc in the magazine or on the plus-1 tray.

Refer to pages 42, 43 for disc loading.



All disc indicators light regardless of how many discs are in the magazine.

2 Start playback.

Select the desired disc.

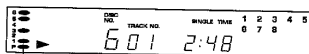
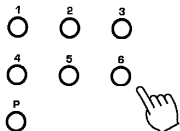

If there is no disc in the selected disc tray, the corresponding indicator goes out.

- Playback starts from the selected disc. If more than two discs are loaded, the discs are played in order of their disc numbers.
- If the play key is pressed without selecting a disc, the discs will be played automatically in the following order: P → 1 → 2 → 3 → 4 → 5 → 6. (P: Plus-1 tray)
- To play a single disc only, remove the magazine and place a disc only in the plus-1 tray.

To pause playback



To resume playback, press the key again.

To stop playback



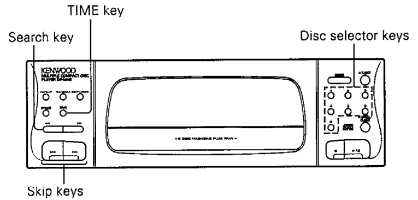
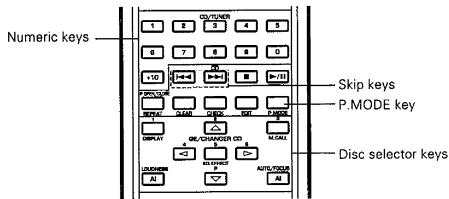

■ Listening from the desired track
Preparation: Select CD with the input selector key of the receiver unit.

1 Make sure the PGM indicator is extinguished.

If the **PGM** indicator is lighted, press the **P.MODE** key. (Remote control unit only)

2 Select the desired disc.

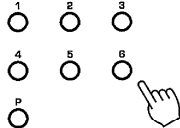

3 Select the desired track.

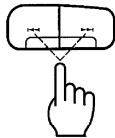

Continue pressing until the desired track No. appears.

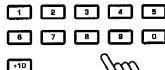

Numeric keys of remote control unit

Example: To select track number 11, press the **[+10]** key once and then the **[1]** key once.
 To select track number 20, press the **[+10]** key twice and then the **[0]** key once.

- Play starts from the selected tune and after.

To skip tracks

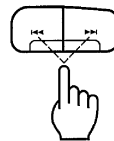

- The tunes are skipped in the direction of the key and the play starts at the beginning of the selected tune.
- When the **[←]** key is pressed once during play, the track starts again from the beginning.

To fast forward and backward

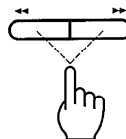

- The track will start to play from where you release the key.

TIME key

Press the **TIME** key when you want to check the elapsed time and remaining time of the track being played. Every time the **TIME** key is pressed, the displayed time changes as shown below. The time information display may not appear when playing a CD containing 21 or more tracks. In such a case, the display (remaining SINGLE TIME) will show "--:--". (In PGM mode, only the SINGLE TIME displays can be selected.)

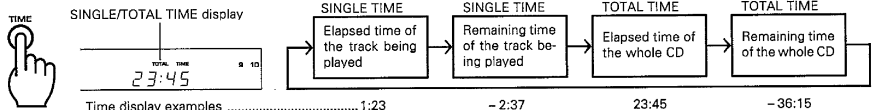

Playing CDs (UD-700M)

The program mode allows you to play desired tracks in the order you want to hear them. A maximum of 32 selections can be entered in memory.

Preparation: Select CD with the input selector key of the receiver unit.

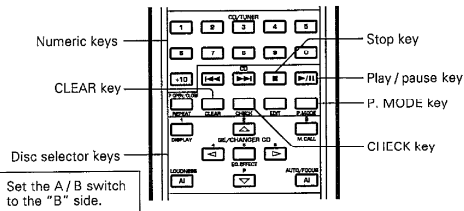

■ Playing desired tracks in desired order (PGM mode) Remote control unit only

1 Enter the PGM mode.

Press the P. MODE key.
PGM indicator lights up.

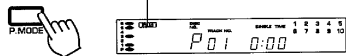

2 Program desired tracks in desired order.

Example

To select track no.5 on disc 4:

- ① Select the disc.

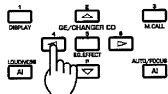

- If more than eight seconds elapse before proceeding to step ②, all tracks on the selected disc will be programmed. (1-DISC program)

- ② Select the track.



- Repeat steps ① and ② to program up to 32 tracks. When 32 tracks have been programmed, "FULL" appears on the display.

If you make a mistake during entry:
Press the CLEAR key and re-enter the correct number.

3 Start playback.



- Tracks are played in the order they are programmed (P-No.).
- If one of the skip keys (▶▶ or ◀◀) is pressed during programmed playback, the track being played is skipped in the forward or reverse direction.

To check the programmed order



- Every time the CHECK key is pressed, the track No. and the order it was programmed (P-No.) are displayed in the order of programming.
- The previous display will resume in a few seconds.

To resume normal playback



- The playback in the order of the track Nos. on CD will start after the track being played.

To stop programmed playback

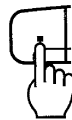

Main unit



Remote control unit

■ To add a track to the program

Remote control unit only

Press the key(s) for the track No. to be added.

① Select the disc.

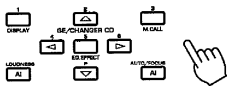

② Select the track number.

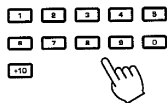

■ To clear tracks from the program

Clearing from the last track



- Every time the key is pressed, tracks are cleared from the last track in order.
- The currently playing track cannot be deleted.

■ To change a track in the program

Remote control unit only

1 Press the CHECK key.



P.C. indicator lights up.

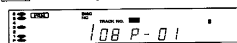

Press until the P.No. to be changed is displayed.

2 Select the track No. to replace the previous one.

① Select the disc.

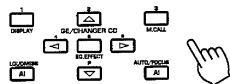

② Select the track number.

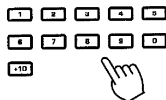

Press while the P.C. indicator is lighted.

- The track being played cannot be changed.

Clearing the whole of program

Press either key.



Remote control unit

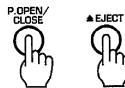

Main unit

Auto-Space function

During playback in the program mode, when the [SPACE] key is pressed, a space of about 4 seconds is reserved automatically between the programmed tracks. This function is provided to facilitate the DPSS function of the cassette deck. However, such a space could also be reserved in case the sound of two tracks are continued, for example with some classic music and live recordings.

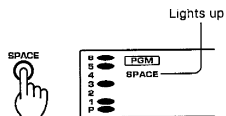

- To cancel Auto-Space function, press the [SPACE] key again.

■ Repeated playback (Preparation : Select CD with the input selector key of the receiver unit.)

Remote control unit only

Repeated playback of programmed tracks

1 Enter the PGM mode.

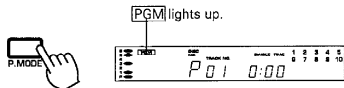

2 Select the desired track(s).

① Select the desired disc.

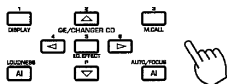

- If more than eight seconds elapse before proceeding to step ②, all tracks on the selected disc will be programmed. (1-DISC program)

② Select the desired tracks.

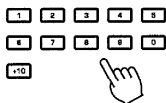

- All of the selected tracks will be played repeatedly.
- If only one track is selected, that track will be played repeatedly.

3 Press the REPEAT key.

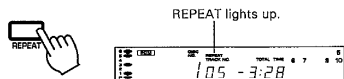

4 Start playback.



Repeated playback of the whole CD

1 Extinguish the PGM indicator.

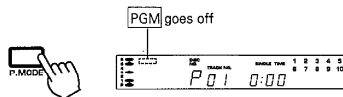

2 Press the REPEAT key.

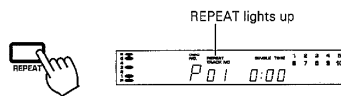

3 Start playback.



To resume normal playback

Press the **REPEAT** key again.



- The playback will be resumed under the CD player mode set before the repeat.

This function allows for random selection of the tracks each time and continuous playing in any order. It lets you enjoy hours of tireless track listening.

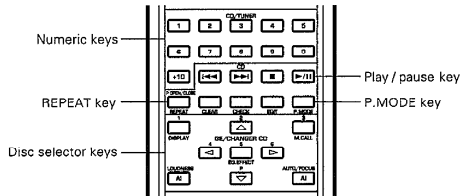
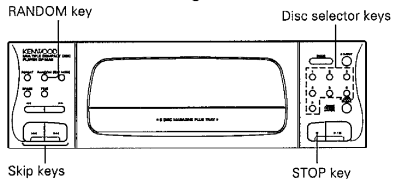

■ **Playing tracks in a random order**

1 Make sure the PGM indicator is extinguished.

- If the [PGM] indicator is lit, press the [P.MODE] key to extinguish the [PGM] indicator.

2 Select the desired random mode.

To randomly play a single disc

① Select the disc.

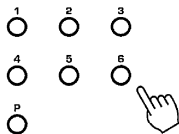

Select RANDOM ONE.

To randomly play all discs



Select RANDOM ALL.

Each press changes the random mode as shown below.

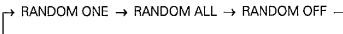

- Tunes are selected and played at random from all of the discs.

Display when track 7 of disc 3 is selected first

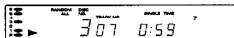

- When one tune ends, the next tune is randomly selected and played.

Display when track 3 of disc 5 is selected next

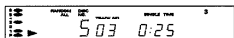

To select another track during random play

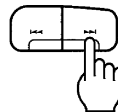

- When the [REPEAT] key is pressed once during random play, the track starts again from the beginning.

To cancel random play

Select RANDOM OFF.



Each press changes the random mode as shown below.

RANDOM ONE → RANDOM ALL



- Normal play starts.

or



- Playback stops.

Note:

The same track will not play twice over continuously, however, it may happen that the same track is repeated later in play.

Playback operation of cassette decks

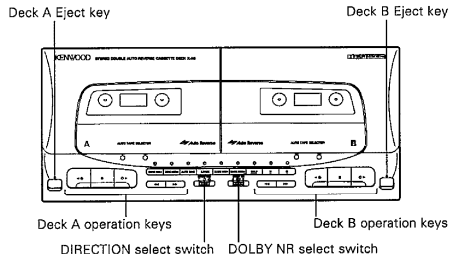

■ To playback a tape

1 Insert a cassette tape.

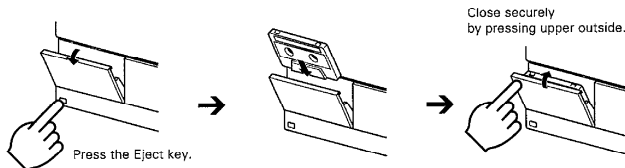

- The type of tape, Normal, Chrome or Metal, is detected and set automatically.
- Be sure to remove tape slack before insertion.

2 Determine the playback conditions.

① Select the playback mode.



- To play both sides endlessly.
- To stop after playing both sides of tape.
- To stop after playing one side of tape.

② Select the Dolby NR mode.



Select according to the tape to be played.

3 Start playback.

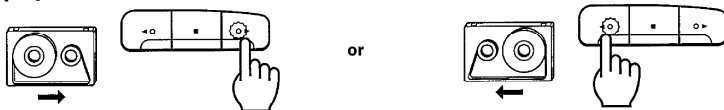

To stop playback

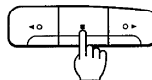

- Do not press the Eject key until the tape has stopped completely.

Dolby noise reduction system

The Dolby noise reduction system was developed to reduce the tape hiss noise generated during playback.

The optimum effect of the Dolby NR system is obtained when the same type NR system is used for both recording and playback. If a different type NR system is used, playback is not performed correctly. Make sure that the same type noise reduction system is used for both recording and playback.

Dolby B NR

The most popular noise reduction system used in home audio components. Usually, Dolby NR system corresponds to B NR.

Dolby C NR

Dolby C NR offers improved noise reduction performance over that of the Dolby B NR. It features a superior noise reduction effect. Use Dolby C NR to record or playback with this unit.

It is recommended that tapes recorded with the Dolby NR system be marked "B" or "C", so that they can easily be distinguished.

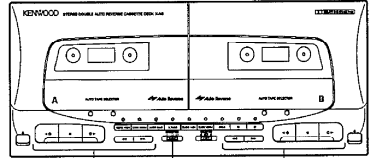

Deck A operation keys Deck B operation keys
DIRECTION select switch

■ To wind the tape at high speed

1 Stop playback.

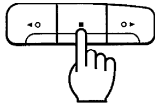

2 Press the ◀◀ key or ▶▶ key.

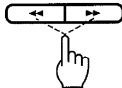

◀◀: Fast tape winding in the ← direction

▶▶: Fast tape winding in the → direction

To stop fast tape winding

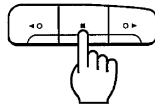

Tape transport direction indicators

The direction in which tape is transported during playback or recording is indicated by the lighting of one of the indicators ◀ and ▶. The direction selected when the tape was stopped the last time is maintained even after the power is turned off. When the tape is started automatically by the automatic play operation, etc., the transport starts with the direction shown by the direction indicator. If you want to change the transport direction for the next time the power is turned on, press the play key of the opposite direction before turning power off.

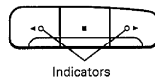

Indicators

■ Relay playback

This function plays back the tapes in both decks A and B continuously and repeatedly.

1 Insert tapes.

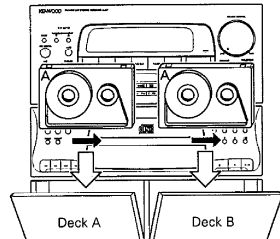

- Tapes are played in the directions indicated by their respective indicators.

2 Select the playback mode.



- ◀▶ Relay playback of both sides of tapes in decks A and B is repeated.
- Relay playback of only one side of tapes in decks A and B is repeated.

- Relay playback cannot be performed if the DIRECTION select switch is set to "◀".

3 Start playback.

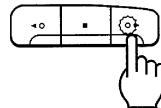

- The playback starts with the deck the play key of which is pressed.

DPSS operation

The DPSS (Direct Program Search System) enables the following convenient operations according to the instructions of the operation keys (these operation are, however, not available on both decks simultaneously). The DPSS functions are based on the detection of non-recorded spaces of 4 seconds or more between tunes.

1. **Skip play** : By specifying a tune located several tunes beyond (or behind) the tune being played, skips tunes between the current tune and the selected tune, and starts playback from the beginning of the selected tune. Up to 16 tunes can be skipped in Skip Search.
2. **Single-tune repeated playback** : One single tune is played back repeatedly up to 16 times.
3. **Rewind & Play** : Rewinds the tape to the beginning and starts playback from there.
4. **Dash & Play** : If a non-recorded space of more than 10 seconds is detected during playback, that space will be skipped by fast forward tape winding.

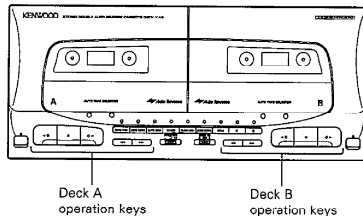
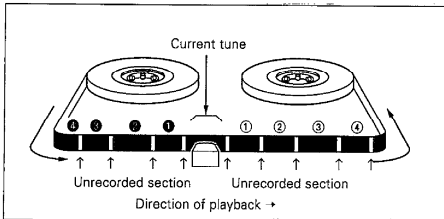

■ Skip play operation

The example below shows the case in which the direction indicated by the tape transport direction indicator is ►. If the direction indicated by the tape direction indicator is ◀, always press the keys for the opposite directions to those shown in the illustrations below.

To play a tune located immediately after the tune being played.

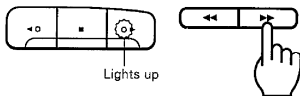

Press once during the playback.

To play the tune being played from the beginning.

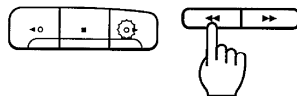

Press once during the playback.

To play a tune located 4 tunes beyond.



Press 4 times during the playback.

To play the tune located 4 tunes behind.

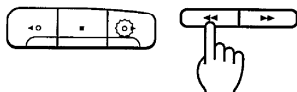

Press 5 times during the playback.

The DPSS will not function properly with the following types of tapes.

- Tapes containing spaces of 4 seconds or more, such as conversations and speeches.
- Tape containing extremely low levels or non-recorded spaces in the middle of tunes, such as classical music.
- Tapes containing recording of large noise between tunes.
- Tapes containing spaces of less than 4 seconds between tunes.
- Tapes recorded with low recording level.
- Tapes recorded using Cross-fade recording.

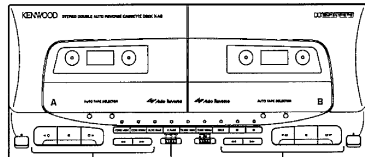

Deck A operation keys

Deck B operation keys

DIRECTION select switch

■ Rewind & Play operation

This operation is not available from the remote control unit.

Direction of tape direction indicator: ▶

Lights up.

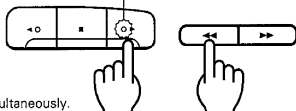

Press simultaneously.

Direction of tape direction indicator: ◀

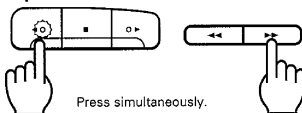

Press simultaneously.

■ Single-tune repeated playback operation

1 Play the tune to be repeated.

2 Press the play key of the same direction as the current tape transport direction.

When direction of tape direction indicator is: ▶

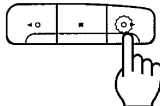

- Normal playback resumes after repeating the same tune for 16 times.

■ Dash & Play operation

The Dash & Play skips long non-recorded spaces automatically as the tape is played.

This operation is not available from the remote control unit.

1 Determine the playback mode (conditions).



- Two sides are repeated 8 times, after which playback stops.
- ▷ Two sides are repeated only once, after which playback stops.
- ≡ One side is repeated 8 times, after which playback stops.

- In case the DIRECTION select switch is set to "▷" and tapes are inserted in both of the decks, when a deck finishes Dash & Play, the other deck starts Dash & Play for 16 times, after which it stops.

2 Press the ◀◀ and ▶▶ keys simultaneously.

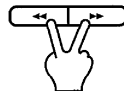

To cancel the playback above in the middle

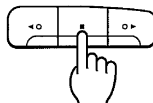

- Playback is stopped.

Recording operation on cassette deck (Deck B only)

The cassette deck incorporates the Dolby HX Pro headroom extension function and auto-bias function to provided a recording with superior high-frequency characteristics.

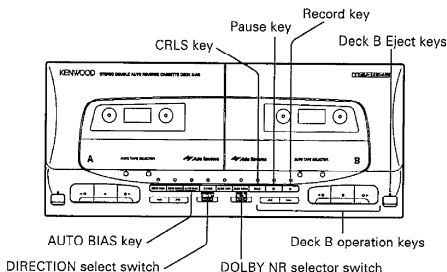

■ Ordinary recording

1 Set up the cassette deck.

- 1 Insert a tape in Deck B.

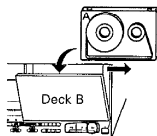

- 2 Set the tape transport direction.

- 3 Select one-side or two-side recording.

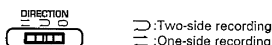

- 4 Select the Dolby NR mode.



- When the microphone is not to be used, be sure to set the MIC MIXING control fully counterclockwise.

2 Select the source to be recorded.



Select a music source other than TAPE.

To apply the equalizer effect

Press the EQ.EFFECT key on the graphic equalizer unit to ON, and select a pattern.



- When recording a tape to be played on a car stereo or headphone stereo, the use of the REC MODE key is effective. (Refer to page 32.)

Auto-bias function

The tapes categorized as "normal" or "chrome" tape vary widely in the characteristics from popular to high-class types. Therefore, this system is equipped with the auto-bias adjustment function for exclusive use with normal or chrome tapes so that optimum recording can always be obtained with any types of normal or chrome tapes. It is recommended to use the auto-bias function when using a normal or chrome tape.

3 Activate the auto-bias setting.

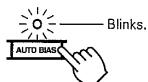

- The optimum bias is set in about 45 seconds, after which the deck enters the stop mode.
- To cancel the auto-bias adjustment operation in the middle, press the Stop key.
- Recording is possible even when the auto-bias setting is omitted.

4 Set the recording level.

- 1 Play a music source.
- 2 Press the CRLS key.

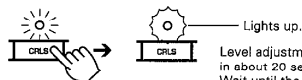

Level adjustment completes in about 20 seconds. Wait until the indicator lights steadily.

- The deck enters the record-pause mode.
- If you press the Record key while the indicator is blinking, the recorded sound may distort.
- When the [CRLS] key is pressed while the indicator is blinking, the level adjustment is terminated at that moment and the deck enters the record pause mode.
- The recording level setting is suspended if the sound of source is not input within about 5 second after the [CRLS] key has been pressed.

5 Start recording.

- 1 Play the music source from the beginning.
- 2 Press the [RECORD] key.

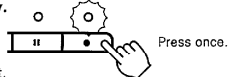

- Recording will start.
- The deck enters the stop mode automatically when the tape has been recorded till the end.

- During auto-bias adjustment, the keys are defeated except for the [STOP], [REVERSE] and [PAUSE] keys of Deck A and [EJECT] key of Deck B.
- If the amount of remaining tape is small, the auto-bias adjustment may be canceled in the middle and tape stopped at that position.
- The auto-bias level is canceled when the [EJECT] key of Deck B is pressed.

■ To pause recording temporarily

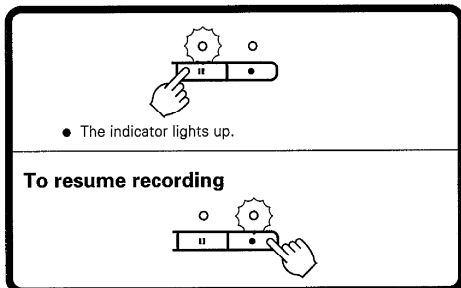

■ To stop recording

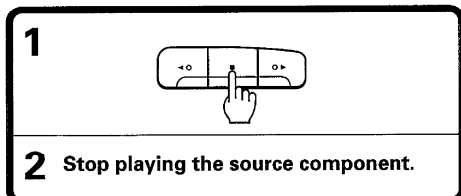

■ To re-start recording after mistake

The following procedure is useful when you want to cancel recording in progress and restart it.

A non-recorded space of about 4 seconds or more should be reserved before the position where recording was started.

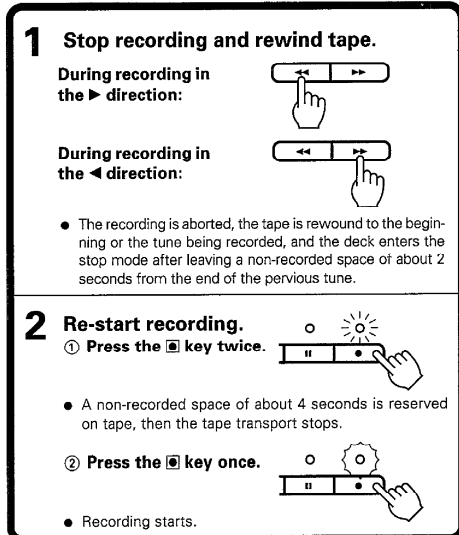

CRLS

CRLS (Computer-controlled Recording Level System):

This function sets the optimum recording level automatically based on the sampling of the levels of a musical source for about 20 seconds.

- Even when you do not press the keyRecording is performed with the basic recording level. The basic recording level common for all input select keys has been set at the factory.
- The level is stored in memory once it has been setThe level determined by the key for each input source (LD / AUX, VIDEO, MD / DAT, TUNER, CDI) is stored in memory. From the next time, the same level is recalled for the same source and applied for recording even when the key is not pressed.
- To re-use the previous level after having pressed the keyPress the Stop key while the CRLS indicator is blinking to re-use the previously-set level.
- When the key is held depressed for more than 3 secondsThe indicator blinks at low speed the goes out. At this time, the CRLS level which has been stored for the input source being indicated returns to the basic recording level.

Recording with Dolby HX Pro

When recording on B deck, the Dolby HX Pro headroom extension function automatically operates to provide a recording with superior high-frequency characteristics.

What is Dolby HX Pro ?

In ordinary recording using high-frequency biasing, the high-frequency bias current, which should be constant, is increased with some recording sources due to the high-frequency component contained in the music, etc. This increase affects the recording characteristics with distorted high frequencies and degraded dynamic range and frequency response.

The Dolby HX Pro circuit detects the high-frequency component contained in the music source being recorded, and reduces excessive bias current to make it constant. As a result, the recording characteristics of high frequencies are drastically improved, and the improved high-frequency reproduction can also be enjoyed even when the tape is played on tape decks which are not equipped with circuit.

Recording operation on cassette deck (Deck B only)

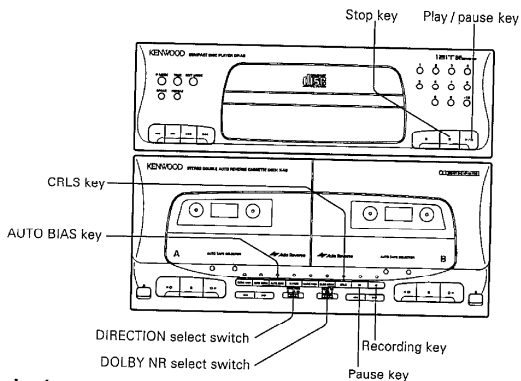

■ Synchro recording of CD

The cassette deck and the CD player can be started simultaneously.

1 Set up the cassette deck.

- ① Insert a tape in deck B.

- ② Set the tape transport direction.

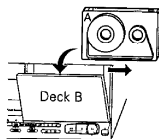

- ③ Select one-side or two-side recording.



☐ : Two-side recording

☐ : One-side recording

- ④ Select the Dolby NR mode.



2 Activate the auto-bias setting.



- The optimum bias is set in about 45 seconds, after which the deck enters the stop mode.

3 Adjust the recording level.

- ① Play a CD.

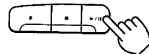

- With the UD-700M (DP-MA9) system, select the desired disc.

- ② Press the CRLS key.

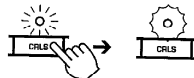

Level adjustment completes in about 20 seconds.

Wait until the indicator lights steadily.

- The deck enters the record-pause mode.

- ③ To pause CD play.

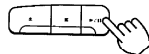

4 Start playing the CD.

- ① Select the desired tracks with the numeric key.
② Start playback.

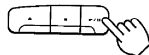

- Recording starts at the same time.
- When the CD player has completed playback, the cassette deck stops recording and enters the stop mode.

To pause recording

Press the [EJECT] key of the CD player.

To resume recording

Press the [EJECT] key of the CD player.

To stop recording

Press the [STOP] key of the CD player.

- When the [STOP] key on the cassette deck is pressed, the cassette deck enters the stop mode, but the playback of CD does not stop.

■ Operation of CD REC key

The CD REC key allows to listen to another music source while recording a CD.

1 Press the CD REC key of the receiver.

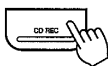

2 Start recording the CD.

- Refer to "Synchro recording of CD" and "Recording of CD playback (CCRS)".

3 Select the music source to be listened to.

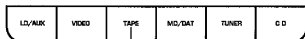

Select a music source other than TAPE.

To cancel CD RED operation

Press the key again.

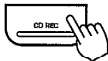

- This key is not accepted while the record indicator is lighted or blinking.

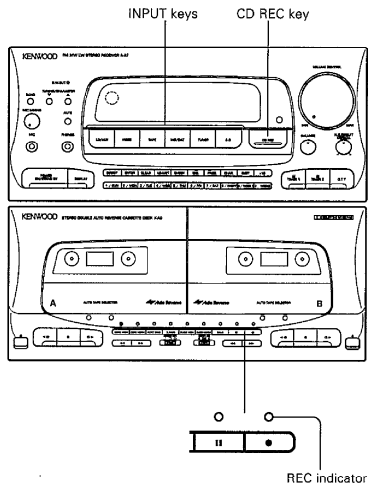

Notes:

1. When the **CD RED** key is set to ON, the CD sound cannot be recorded with the equalizer effect.
2. After CD REC recording, be sure to press the **CD REC** key to turn CD REC OFF.

Recording of CD playback (CCRS)

The CCRS (Computer-controlled CD Recording System) makes the following convenient recordings possible by setting the optimum recording level and recording bias for the specific CD to be recorded and starting recording automatically. (CCRS recording is available only with Deck B.)

Recording of TRACK mode playback : CCRS starts recording the CD tracks from the first track in order. When the end of one tape side is reached during recording, fade-out occurs there, and recording is continued on the other side of tape, which starts with fade-in.

Recording of PGM mode playback : CCRS starts recording the programmed CD tracks in the programmed order. When the end of one tape side is reached during recording, the track which should end in the middle is erased, and the recording on the other side of tape is started from the beginning of that track. (Programming back and forth between several discs is not possible.)

Normal EDIT recording : When programming tracks on two discs or more, perform the MULTI EDIT recording. When the recording time of the tape is specified first, the order of the CD tracks are edited so that no track is interrupted at the end of each side of tape. The maximum number of tracks that can be edited is 20. [PRIORITY EDIT (UD-700 only): By programming desired tunes beforehand, those tunes will be given priority during the editing selection process.]

AI EDIT recording : When the total playing time of a CD exceeds the recording time of tape, all tracks can still be accommodated in the tape by fading out the end of each track. [AI PRIORITY EDIT (UD-700 only): By programming desired tunes beforehand, those tunes will be given priority during the editing selection process and will not be fade-out during recording]

MULTI EDIT recording : Tracks on multiple CDs can be edited and accommodated in a single tape.
X.FADE (Cross-fade) recording : The beginning and end of each track is faded in / out to create a music tape without interruption between tunes.

CCRS double-speed recording : Records CD at twice the normal speed.

Also, refer to "Playing CDs".

CCRS (Computer-controlled CD Recording System)

When the CCRS key is pressed, the following operations occur automatically and recording of CD starts after them.

1. The CD is played and its peak level is sampled from the level used when the disc was recorded.
2. The optimum recording level for that disc is determined from the sampled peak level and the cassette deck is set accordingly.
3. The cassette deck sets automatically the optimum bias for the tape used in recording.
4. The recording preparations detailed above are completed in about 90[~]3 seconds, after which actual recording starts.
5. When the recording is completed (when the CD player ends playback or when the tape has been recorded), both the cassette deck and CD player enter the stop mode.

- The set recording level and auto bias level are maintained while the CCRS and AUTO BIAS indicators are lighted.
- The recording level is canceled when the open / close key of the CD player is pressed, the auto bias level is canceled when the Eject key of Deck B is pressed, and both are canceled if the power is turned off.

Display during CCRS operation

Indicator	Lighting ○ Blinking ☀ OFF ●			
	CCRS ₁	AUTO BIAS ₂	Pause	Recording
During recording level setting	☀ Quick blinking	●	○	○
During auto bias adjustment	☀	☀	●	○
	☀	☀	●	●
During recording	☀ Slow blinking	○	●	○
During record-pause	○ UD-700 ● UD-700M	○	●	●

*1. To cancel CCRS setting : Press the open / close key of the CD player.

*2. To cancel auto bias setting : Press the Eject key of the cassette deck.

*3. The time varies according to the number of the tunes to be recorded.

Fade-in and fade-out

Fade-in refers to a gradual increase of volume from the minimum to normal level when starting to play music. Inversely, fade-out refers to a gradual decrease of volume from the normal to minimum level at the end of music.

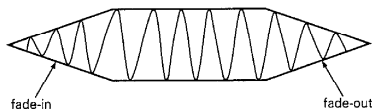

CCRS double-speed recording

CD and cassette deck are both played at twice the normal speed and recorded, making it possible to half the time required for recording.

Since the CD is played in double speed in this case, the recorded content cannot be enjoyable as music even though it can be monitored from the speakers.

In double-speed recording, tunes are recorded onto the tape without DOI BY NR effect. So playback the tape without DOLBY NR effect.

Cancel the equalizer effects before starting the CCRS double-speed recording. (Refer to page 33.)

■ Recording of CD playback in TRACK mode

Fade-out and fade-in occur at the end of tape where it is reversed.

1 Select CD with the input selector, and place a CD the tray.

2 Perform "Ordinary recording" until step 2.

- Refer to page 54.

3 Check that the CD player is in the TRACK mode.

- If the [PGM] indicator is lighted up, press the [P.MODE] key.

With the UD-700M (DP-MA9) system, press the disc selector key to select the disc to be recorded.

- Check the playback sound.

4 Start recording.

Normal-speed recording

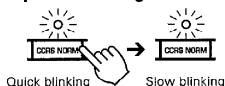

Double-speed recording



- The CCRS is activated so the recording will start in about 90 seconds.
- The tracks on the disc are recorded in the order of the track Nos.
- The operations as shown below occur at the end of tape where it is reversed.

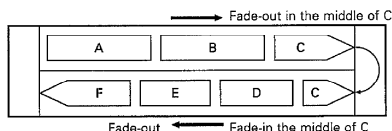

■ Recording of CD playback in PGM mode

Tracks are recorded so that they do not end in the middle at the end of tape.

1 Select CD with the input selector, and place a CD on the tray.

2 Perform "Ordinary recording" until step 2.

- Refer to page 54.

3 In the PGM mode, select the order of tracks to be played.

- For programming with the UD-700M system, refer to page 46. For programming with the UD-700 system, refer to page 39. (Programming back and forth between several discs is not possible.)
- When programming tracks on two discs or more, perform the MULTI EDIT recording described on page 62.

4 Start recording.

Normal-speed recording

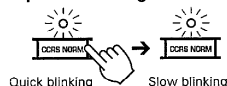

Double-speed recording

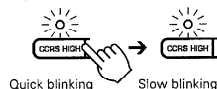

- The CCRS is activated so the recording will start in about 90 seconds.
- The tracks on the disc are recorded in the programmed order.
- The operations as shown below occur at the end of tape where it is reversed.

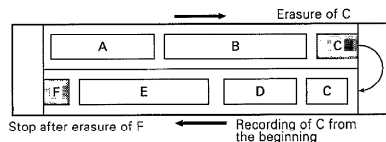

Notes:

1. When the [CCRS] key is pressed during CD playback, the playback is stopped and CCRS setting operation starts.
2. The CCRS recording makes it unnecessary to adjust the recording level manually.
3. The CCRS searches the peak level on a CD in a limited period of about 90 seconds. Therefore, it could happen that the optimum level cannot be adjusted, though it is a very rare case.
4. If the length of a track on the CD is extremely long such as with a classical music, the CCRS cannot be used because the music cannot be fit in one side of tape.
5. When the DIRECTION select switch of the cassette deck is "←" the tape end processing occurs only on the A side of tape.
6. When the tune being recorded at the end of the tape is to be faded out, the ending part of the previous tune may also be faded out if the space between the tunes is short.

■ Normal EDIT recording

This function allows to edit, base on the recording time of the tape specified, the order of the CD tracks so that no track is interrupted at the end of each side of tape.

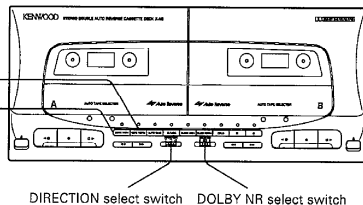

1 Set up Deck B ready for recording.

- 1 Insert the cassette tape.

- 2 Check the tape transport direction.

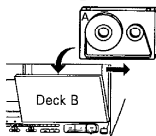

- 3 Select the tape sides to be recorded.



☐ :Select two-side recording.

- 4 Select the Dolby NR mode.



To apply an equalizer effect

Press the EQ.EFFECT key on the graphic equalizer unit to ON, and select a pattern.

2 Select the CD input.

3 Insert the disc in the CD player.

With the UD-700 system:

- When you wish to program tunes, carry out the programming before step 4.
- To use the auto space function (page 40), press the **[SPACE]** key.

With the UD-700M system:

- Close the door.
- Verify that the **[PGM]** indicator is extinguished. If even only one tune is programmed, editing cannot be carried out.

4 Select the EDIT mode with the EDIT MODE key of the CD player.

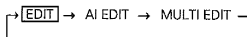

The display changes every time the key is pressed.

- Proceed to the next step within 8 seconds after setting EDIT. If 8 seconds have elapsed, select the EDIT mode again.

With the UD-700M (DP-MA9) system, press the disc selector key to select the disc to be recorded.

5 Input the two-way recording time of the tape.

Use the numeric keys of the CD player.

C-30 tape: **[+10] [+10] [+10] [0]**

C-46 tape: **[+10] [+10] [+10] [+10] [6]**

- 46, 54, 60 or 90 can also be selected every time the **[TIME]** key is pressed. In this case, press the **[EDIT MODE]** key again to establish the input.
- Tracks are edited automatically to fit sides A and B, and the end of editing is indicated when the **[EDIT]** indicator changes from blinking to continuous lighting.
- If a program containing a few tracks has been programmed previously, these tracks can be recorded in priority. (UD-700 only)
- When the **[EDIT MODE]** key is pressed again while **[EDIT]** is lighted, "SHUFFLE" appears on the display and re-editing of tracks is performed. (UD-700 only)

6 Press the CCRS key.

Normal-speed recording

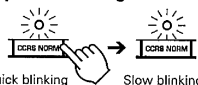

Double-speed recording

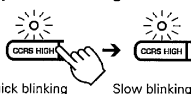

Recording occurs as shown below. (example for the UD-700 system)

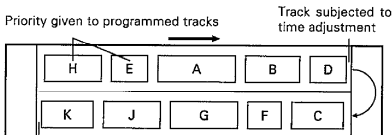

Track subjected to time adjustment
Tracks are recorded basically according to their numbers, but some tracks are replaced with tracks subjected to time adjustment.

- The CD player and cassette deck enter the stop mode automatically after the completion recording.

Notes:

1. Edit operation does not occur if a track No. 44 or more has been programmed. (With the UD-700M system, programming is not possible.)
2. Repeat playback is not available.
3. To cancel the auto-spacing, press the **[P. MODE]** key and re-start the procedure from step 4. (UD-700 only)

■ AI EDIT recording

When the total playing time of a CD exceeds the recording time of tape, this function allows to accommodate all tracks in a tape by cutting the end of each track by means of fade-out. It is also possible to specify the important tracks that must not be cut.

[AI PRIORITY EDIT (UD-700 only)]

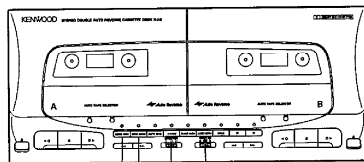

CCRS HIGH key
CCRS NORM key
DOLBY NR select switch
DIRECTION select switch

1 Set up Deck B ready for recording.

- ① Insert the cassette tape.
- ② Check the tape transport direction.
- ③ Select the tape sides to be recorded.

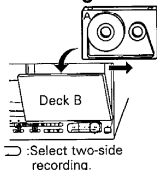

- ④ Select the Dolby NR mode.



To apply an equalizer effect

Press the EQ.EFFECT key on the graphic equalizer unit to ON, and select a pattern.

2 Select the CD input.

3 Insert the disc in the CD player.

- With the UD-700M system, close the door and make sure the [PGM] indicator is extinguished.

4 Select the tracks which must not be cut in recording.

UD-700 only:

- ① Press the P.MODE key.
 - [PGM] lights up.
- ② Input the track Nos. using the numeric keys.
 - Input several numbers in a desired order.
 - For details, refer to "Playing desired tracks in desired order" on page 39.

5 Select the AI EDIT mode with the EDIT MODE key of the CD player.



EDIT → AI EDIT → MULTI EDIT

The display changes every time the key is pressed.

- Proceed to the next step within 8 seconds after setting AI EDIT. If 8 seconds have elapsed, select the AI EDIT mode again.

With the UD-700M (DP-MA9) system, press the disc selector key to select the disc to be recorded.

6 Input the two-way recording time of the tape.

Use the numeric keys of the CD player.

C-30 tape: [+10] [+10] [+10] [0]
C-46 tape: [+10] [+10] [+10] [+10] [6]

- 46, 54, 60 or 90 can also be selected every time the [TIME] key is pressed. In this case, press the [EDIT MODE] key again to establish the input.
- Tracks are edited automatically to fit sides A and B, and the end of editing is indicated when the [AI EDIT] indicator changes from blinking to continuous lighting.

7 Press the CCRS key.

Normal-speed recording



Double-speed recording

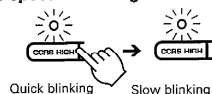

Recording occurs as shown below. (example for the UD-700 system)

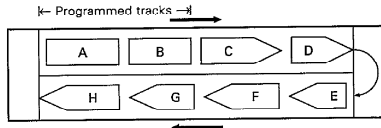

- First, the programmed tracks are recorded without any cutting, the other tracks are recorded with the end of every track cut by fade-out. (UD-700 only)
- If the tape has enough recording time, all tracks are recorded until the end.
- The CD player and cassette deck enter the stop mode automatically after the completion of recording.

Notes:

1. If an extremely-short tape recording time is set, automatic editing may not occur.
2. The [SPACE] key and [REPEAT] key functions are inoperative.
3. Edit operation does not occur if a track No. 44 or more has been programmed. (With the UD-700M system, programming is not possible.)
4. X. FADE recording is not possible.

■ MULTI EDIT (Multiple disc edit) recording

This function allows to edit desired tracks on multiple CDs, each of which containing no more than 20 tracks, and record them on a single tape while replacing discs. With the UD-700M system, load the desired discs for editing into the magazine and plus-1 tray beforehand.

1 Set up Deck B ready for recording.

- ① Insert the cassette tape.
- ② Check the tape transport direction.
- ③ Select the tape sides to be recorded.
 - ▷ :Select two-side recording.
- ④ Select the Dolby NR mode.

To apply an equalizer effect

Press the EQ.EFFECT key on the graphic equalizer unit to ON, and select a pattern.

2 Select the CD input.

3 Insert the disc in the CD player.

- With the UD-700M system, close the door and make sure the [PGM] indicator is extinguished.

4 Select the MULTI EDIT mode with the EDIT MODE key of the CD player.

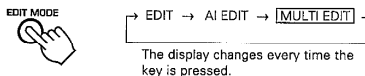

- Proceed to the next step within 8 seconds after setting MULTI EDIT. If 8 seconds have elapsed, select the MULTI EDIT mode again.

5 Input the two-way recording time of the tape.

Use the numeric keys of the CD player.

C-30 tape: [+10] [+10] [+10] [0]

C-46 tape: [+10] [+10] [+10] [+10] [6]

- 46, 54, 60 or 90 can also be selected every time the [TIME] key is pressed. In this case, press the [EDIT MODE] key again to establish the input.
- [MULTI EDIT] changes from blinking to continuous lighting, indicating the program input stand-by, and the recordable time of side A is displayed.

With the UD-700M system, select one of the seven discs loaded in the player.

- To select another disc, press the [] key while the play track number blinks.

6 Select the tracks to be recorded.

Using the numeric keys of the CD player, input the track Nos. in the order they are to be recorded. (on the remote control unit with the UD-700M system)

- The TOTAL TIME display shows the remaining time on the tape side A or B.
- When "FULL" appears on the display, this indicates that tracks cannot be recorded any more.

7 Press the CCRS key.

Normal-speed recording

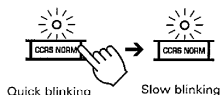

Double-speed recording

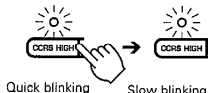

Recording occurs as shown below (example when three CDs are to be recorded).

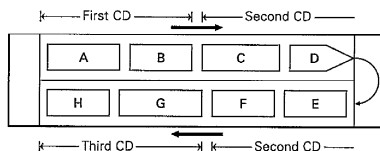

- When the first CD has been recorded, both the CD player and cassette deck enter the stop mode. With the UD-700 system, the tray of the CD player opens automatically.

With the UD-700 system:

To record the second and third CDs, repeat steps 6 and 7 after changing the CDs and closing the tray of the CD player.

With the UD-700M system:

Select another disc and repeat steps 6 and 7.

Notes:

1. In step 6, the display of the CD player shows FADE and the end of the selected tune which is longer than the preset time is faded out.
2. Track No. 44 (21 with the UD-700M system) or more cannot be input.
3. The [SPACE] key and [REPEAT] key functions are inoperative.
4. During recording, do not press the P.OPEN / CLOSE or magazine eject key. (UD-700M)

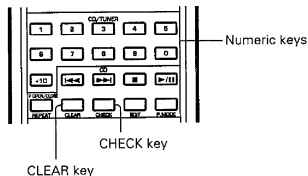

■ To check the edited contents

Remote control unit only

P.C. lights up.

Track No.

- Every time the key is pressed, the track Nos. are displayed in the edited order.
- Only the track Nos. on the disc being present in the CD player are displayed in case of MULTI EDIT. (With the UD-700M system, tunes from only the currently selected disc are deleted.)

■ To clear the edited contents

Remote control unit only

Clearing individual tracks from the last track (MULTI EDIT only)

- Every time the key is pressed, the last track in the edited sequence of tracks is cleared.
- Only the track on the disc being present in the CD player can be cleared. (With the UD-700M system, tunes from only the currently selected disc are deleted.)

Clearing all edited contents

or

(UD-700), (UD-700M)

- Only the track on the disc being present in the CD player can be cleared in case of MULTI EDIT. (With the UD-700M system, tunes from only the currently selected disc are deleted. While playing a disc in plus-1 tray, press the P.OPEN / CLOSE key.)

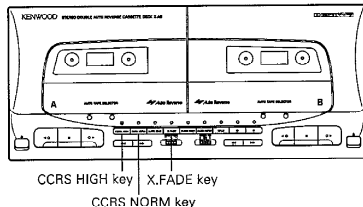

■ X.FADE recording of CD playback

Not available with double-speed recording

1 Select CD with the input selector, and place a CD on the tray.

- For normally playback with the UD-700M (DP-MA9) system, press the disc selector key to select the disc to be recorded and check the playback sound.

2 Perform "Ordinary recording" until step 2.

- Refer to page 54.

3 Start recording.

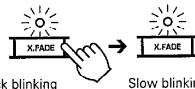

- The CCRS is activated so the recording will start in about 90 seconds.
- The recording operation according to the mode of the CD player starts.

In case of TRACK or PGM mode

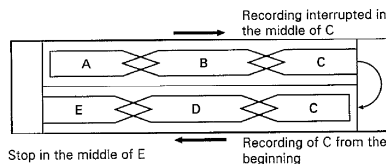

In case editing (Normal EDIT, MULTI EDIT) is executed before recording

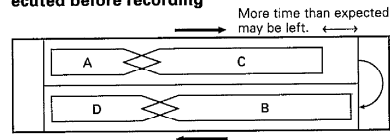

Note:

If a tune beginning and ending with fade-in and fade-out is recorded by X.FADE recording, spaces between recorded tunes may become very long.

Tape dubbing

The dubbing refers to the copy of the recorded contents of a tape to another tape (tape in Deck A → tape in Deck B).

Normal-speed dubbing: Copy at normal tape speed.
High-speed dubbing: Copy at double the normal speed.

1 Insert tapes in the cassette decks.

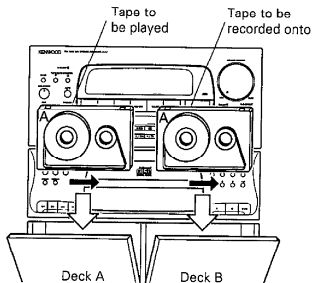

2 Set the same tape transport direction for both tapes.

- Refer to page 51.



3 Select one-way or two-way dubbing mode.



- ▷: For two-way dubbing
- ◁: For one-way dubbing

4 Press the AUTO BIAS key.

- The optimum bias is set in about 45 seconds, after which the cassette decks enter the stop mode.

5 Start dubbing.

For normal-speed dubbing

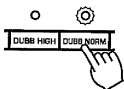

For high-speed dubbing

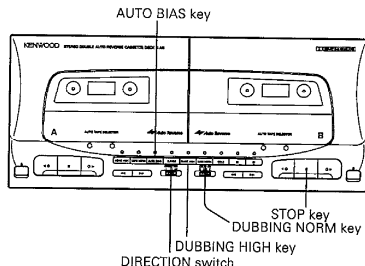
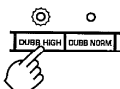

To stop dubbing

Press the Stop key of Deck B

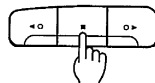

- Both Decks A and B enter the stop mode.

To pause dubbing

Normal-speed dubbing: Press the NORM key.

High-speed dubbing: Press the HIGH key.

- Only deck B enters the record-pause mode after leaving a non-recorded space of about 4 seconds in case of normal-speed dubbing, or about 6 seconds in case of high-speed dubbing.
- To skip tunes you do not want to dub on another tape during dubbing, press the [▶] key of Deck A.
- To resume dubbing after pause, press the same DUBBING key as above ([NORM] or [HIGH]) again.

Notes:

- The recording level cannot be adjusted for dubbing.
- The [DOLBY NR] switch does not function during dubbing.
 * The tape recorded by dubbing features the same NR system as the original tape in Deck A.
- Noise from TV may interfere with dubbed sound if high-speed dubbing is executed near a TV set. To prevent this, install the system farther from the TV set.
- If the original tape was recorded at a high level, the sound quality may be degraded, if high-speed dubbing is used. In such a case, use normal-speed dubbing.

Operation with video components

Please refer to page 12 for the connection of Audio / Visual components.

For the connections and operations, also read carefully the instruction manuals supplied with the video components to be connected.

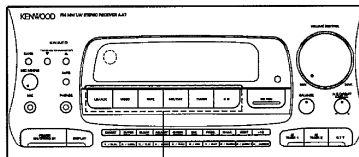

Input selector keys

■ Playback of videotape

1 Switch the power of the monitor TV ON.

2 Set the input selector to VIDEO mode.

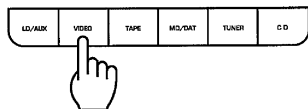

3 Play the VCR.

■ Recording of video source

1 Connect the video component to be recorded.

- A video player deck, video camera, LD player, DBS tuner, etc., can be connected.

2 Select the corresponding input source.

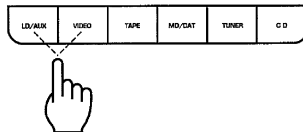

3 Play the video source component.

4 Put the VCR in the record mode.

Simple Karaoke singing entertainment

HIT MASTER:

This key allow to reduce the vocal level of songs played on CD, etc., so that you can sing along with only the accompaniment just like in "Karaoke" singing. This feature is convenient when you want to master a latest song the "Karaoke" backing of which is not available. This function cannot be activated in the DOLBY SURROUND mode.

■ Microphone mixing (Except for U.S.A., Canada, U.K. and Europe)

- 1 Tun the MIC MIXING control fully counterclockwise.



- 2 Insert the microphone plug into the MIC jack.



- 3 Adjust the volume balance between the microphone and source.



■ Singing "Karaoke" (Except for U.K. and Europe)

- 1 Play the music source.
- 2 Press the HIT MASTER key.



- Only the vocal part level is reduced from the music source. However, note that this effect cannot be obtained with certain types of sources.

- 3 Sing along with the music.

- The overall volume is adjusted with the VOLUME CONTROL.

The sets destined for the U.S.A. and Canada are not provided with the microphone function. This means that these sets can create karaoke accompaniment tapes but cannot record karaoke performance sung through microphone.

The sets destined for the U.K. and Europe are not provided with the functions described on this page.

■ Recording "Karaoke" (Creating karaoke accompaniment tape)

- 1 Connect a microphone.
- 2 Ensure that the CD REC is OFF.

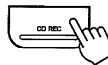

- 3 Press the HIS MASTER key.



- 4 Perform the "Ordinary recording" procedure until step 4.
 - Refer to page 54.

- 5 Start recording.

- ① Play a music source.
- ② Press the record key.
- ③ Sing along with the music.

- A "Karaoke" accompaniment tape can also be created by recording music with the MIC MIXING control set fully counterclockwise.

- 6 Stop recording.

Notes:

1. When the microphone is not to be used, be sure to set the MIC MIXING control fully counterclockwise.
2. The mixture of microphone sound and tape playback sound cannot be recorded.

Presence effect

This system is equipped with the presence modes, which reproduce the atmosphere of presence that surrounds the audience in concert halls and theaters as well as the powerful atmosphere of Dolby Surround movies in movie theaters. The presence effect can be enjoyed by connecting optional speakers. (If you live in other area than the U.K. and Europe, please refer to the separate speaker instruction manual.) For details, read the operation procedures on the subsequent pages.

Presence effects

F.4ch

By connecting optional speakers, five kinds of presence sound field modes (MOVIE, ARENA, JAZZ CLUB, GAME, STADIUM) can be reproduced. (Refer to Figure-2.)

S.4ch

Select this mode when a Surround rear speaker is connected. This effect can also reproduce five presence modes similarly to the F.4ch effect. (Refer to Figure-1.)

AI LINK equalizer effect

When the F.4ch or S.4ch effect is selected, the equalizer curve suited for one of the five presence sound field modes is set automatically for an enhanced presence effect.

DOLBY SURROUND

By playing videotape / LD software carrying the **DD** (DOLBY SURROUND) mark, a similar Dolby Surround effect to movie theaters can be reproduced. (Refer to Figure-1.)

ASFC (Acoustic Surround Field Control)

The presence effect can be enhanced based on the sound expansion control. (F.4ch and S.4ch effects only)

Types and results of presence modes

ARENA	Reproduces the sound field of a hall with many high-frequency reflections and long reverberation period.
JAZZ CLUB	Reproduces a jazz house where the sound of cymbals echoes.
STADIUM	Reproduces the ambience of reflections proper to sport stadiums by simulating the sound of PA speakers.
GAME	Enhances the effects sound of video games to reproduce powerful sound with an atmosphere of presence.
MOVIE	Reproduces the reverberations and atmosphere of presence proper to movie theaters.

■ Speaker layout

Standard layout

DOLBY SURROUND mode.
S.4 ch mode.

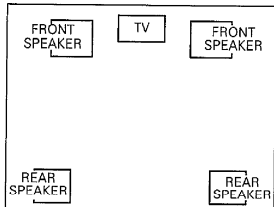

Figure-1

When the surround rear speakers are not used

F.4ch mode.

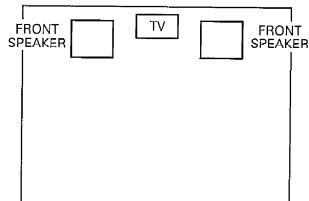

Figure-2

Setting the Delay time **DOLBY SURROUND only**

The delay time should be adjusted according to the difference between the distance from the listening position to the front speakers and the distance to the rear (surround) speakers. Determine the appropriate delay time using the formula shown below.

Relationship between the positioning of the rear (surround) speakers and the delay time at the listening position:

$$\text{Delay time} = 20 \text{ ms} + 3 \text{ ms} \times (A - B) \text{ m}$$

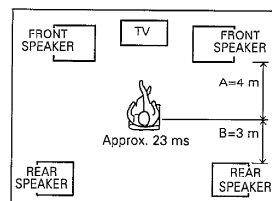
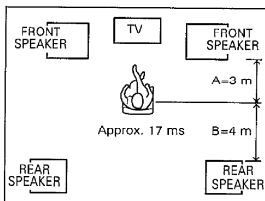
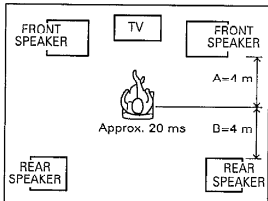

Sound expansiveness **F.4ch, S.4ch**

As shown in the example of illustration, the sound of piano played on the stage attains the ears of listener as a synthesis of the direct sound from piano, the indirect sounds which are reflected once or twice by the reflectors, ceiling and side and back walls, and the reverberation sounds which repeat infinite reflections until they fade out completely.

The indirect sounds always pass through longer routes compared to the direct sound. The delay between the direct and indirect sounds is called the DELAY TIME, and the level of the indirect or reverberated sounds is called the PRESENCE LEVEL. The indirect sounds accompanied with delay play a very important role in providing better sound effects and the feeling of presence of concert halls, etc.

ASFC simultaneously changes both the delay time and reverb sound level. Select the ASFC value which sounds best to you.

Example of a concert hall

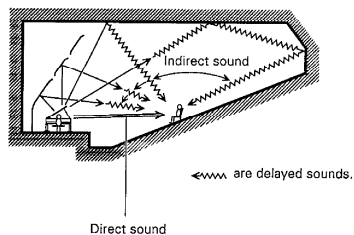

■ Dolby Surround play

When video software carrying  mark is played, this mode provides the similar Dolby Surround effect to movie theaters.

1 Set the Dolby Surround ON.

Press the DOLBY SURROUND key once.



Remote control unit

2 Set the delay time.



Remote control unit

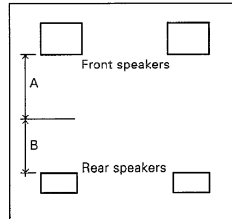

Delay time (ms) = 20 ms + 3 ms (A - B)
A: Distance to front speakers (meters)
B: Distance to rear speakers (meters)

- Refer to the illustration and calculate the special delay time to be used in Dolby Surround play.
- The delay time can be adjusted in the range from 16 to 30 ms.
- The delay time is displayed when the DELAY TIME key is pressed. It can be adjusted in 3 to 4 ms step every time the key is pressed.
- Once set, the delay time is stored automatically in memory, and the same delay time is recalled every time Dolby Surround is activated.

3 Adjust the Dolby Surround input balance.

- ① **Play the video software with the Dolby Surround mark.**
 - Play the scene with a lot of dialogues in the video software to be watched.

- ② **Adjust the balance between the left and right inputs.**

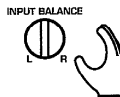

Adjust so that the dialogue sound from the rear speaker is minimized.

- ③ **Stop playing the video software.**

4 Play Dolby Surround video software.

- ① **Play video software recorded with Dolby Surround.**

- ② **Adjust the listening volume.**

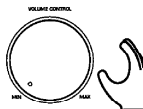

- ③ **Adjust the rear speaker volume.**



Remote control unit Graphic equalizer unit



To return to normal stereo playback from Surround playback



Remote control unit

Presence effect

Various presence modes can be enjoyed by connecting optional speakers.

(If you live in other area than U.K. and Europe, please refer to the separate speaker instruction manual.)

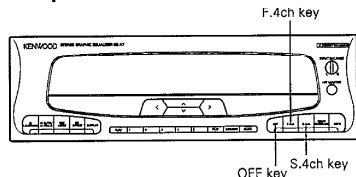
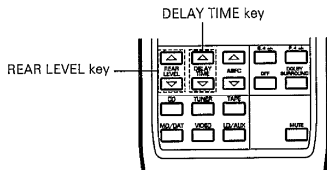

■ Presence playback

1 Play a music source.

2 Select the surround mode.

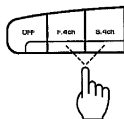

3 Select the presence mode.

Press the **F.4ch** or **S.4ch** key.

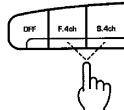

Each press changes the modes as follows.

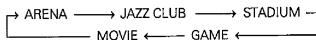

4 Control the sound expansion.

Control the ASFC to adjust the sound field to your taste.



Remote control unit Variation range is from 1 to 5.

5 Adjust the rear speaker volume.

S.4ch only



Remote control unit

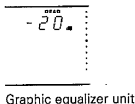

Graphic equalizer unit

■ To cancel presence mode

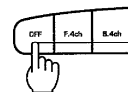

- Be sure to turn the presence mode OFF when the presence effect is not required.

■ Recording with presence effect

S.4ch only

1 Select the surround condition.

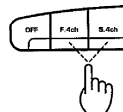

Each press changes the modes as follows.

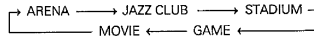

2 Ensure that the CD REC is OFF.

3 Play music and record it.

- Set the recording level using the C.R.I.S and C.C.R.S.

ASFC level

The ASFC level is variable in 5 steps. The larger the figure, the wider the sound expansion. Increasing the ASFC level increases the delay time and presence level, as well as the center level. This provides the sound field with a narrower image.

Operation of timer

Be sure to adjust the present time before proceeding the following.

The timer of the system can be used for the following functions.

- Program timer** : Receives broadcast, records broadcast or plays tape or CD at the specified ON time, and switches power OFF at the specified OFF time. Up to six timer programs can be set. The AI TIMER functions can be added to the program timer function.
- AI TIMER 1** : When the power is switched ON at the timer ON time, the volume will increase in three steps, providing a wake-up effect like an alarm clock.
- AI TIMER 2** : When the power is switched ON at the timer ON time, two tracks of a CD is played first, then the input is switched automatically to the tuner.
- Sleep timer** : Switches power OFF after a set time period has elapsed. If set before you go to bed, power can be switched OFF automatically even after you fell in sleep.
- One-touch timer** : Switches power ON after a specified time period, set in the unit of 30 minutes up to 12 hours, from the moment it is activated. The AI TIMER functions can be added to the one-touch timer function.
- Calendar check** : When the year, month and day are input in this order, the day of the week of that date is displayed by means of an indicator.

- For the timer setting procedures, read description on the next page and after.
- The contents of time programs can be modified as required.
- Even when a timer program has been input, the timer will not be activated unless its execution has been activated.
- Turn the AI TIMER functions OFF when they are not required; otherwise, they will be added to all of the programs executed on that day.
- Once set, the contents of a program cannot be cleared at once. The previous contents can only be cleared when they are replaced by modification.
- The programs must be set so that their time ranges do not overlap.

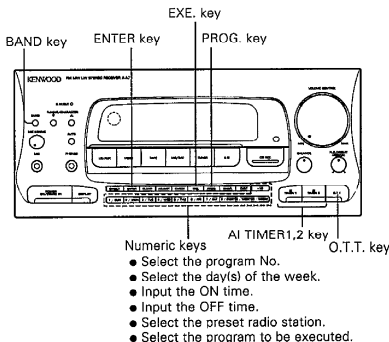
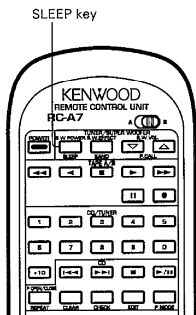

Types of days of the weeks which can be selected by numeric keys

1. To execute a program only once on the specified day of the week after its execution has been activated.

	Numeric keys
Sunday	1 / SUN
Monday	2 / MON
Tuesday	3 / TUE
Wednesday	4 / WED
Thursday	5 / THU
Friday	6 / FRI
Saturday	7 / SAT

- If it is required to activate the timer in the same time period of the next week, activate the execution again.

2. To execute a program repeatedly on every week after its execution has been activated.

	Numeric keys
Every day from Monday to Sunday	8 / EVERY
Every day from Monday to Saturday	9 / WEEK
Every day from Monday to Friday	0 / WEEK

- If timer operation is not required, cancel the program execution.

Operation of timer

Be sure to adjust the present time before proceeding the following.

■ Timer reception of radio broadcast

1 Switch the power ON.

Press the **[POWER]** key of the receiver.

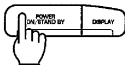

2 Select the program setting mode.



- The program No. indicators (1 to 6) blink.

3 Select the program No. to be used.

1 / SUN 2 / MON 3 / TUE 4 / WED 5 / THU 6 / FRI

Select from 1 to 6.

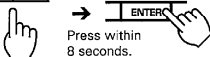

- The selected program No. indicator blinks.

4 Specify the day(s) of the week with the numeric keys.

0 / ALL 1 / SAT 2 / SUNDAY 3 / WEEK 0 / WEEK



5 Input the ON time with the numeric keys.

6:30 AM: 0 6 3 0 INPUT ON TIME



6 Input the OFF time with the numeric keys.

7:00 AM: 0 7 0 0 INPUT OFF TIME



7 Select the PLAY mode.

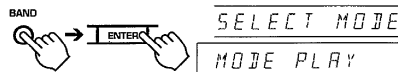

The timer modes are switched between PLAY and REC every time the **[BAND]** key is pressed.

8 Select the TUNER source.

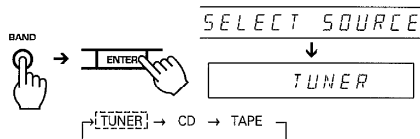

The sources are switched every time the **[BAND]** key is press.

9 Select the preset key under which the station to be received has been preset.

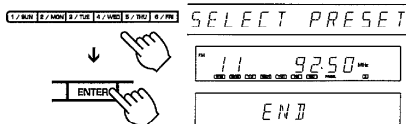

- The station must be preset previously.

10 Activate the execution of the program.



- Select the program No. to be executed by pressing the numeric key under which it is set.

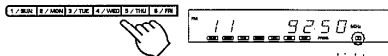

Lights up.

- The selected program No. indicator lights up.

11 Adjust the volume and tone.

12 Switch the power OFF.

Press the **[POWER]** key of the receiver.

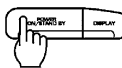

To continue the reception of radio station which as been started to be received by timer ON:

- Press the **[CLEAR]** key before the OFF time comes.
- Press the numeric key for the program No. being executed.

- The program No. indicator goes off, it means that the program will be received continuously.

Notes:

- When a program has previously been set in the program No. selected in step 3, the newly-set program replaces the previous program.
- Do not operate the **[CLEAR]** key or **[POWER]** key while the timer program execution has been activated; otherwise malfunction will occur.

To change the program
During the setting
operation



After setting is
completed

Repeat the program-
ing procedure from
step 2.

■ Timer playback of CD

1 Switch the power ON.

Press the **[POWER]** key of the receiver.

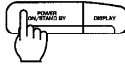

2 Select the program setting mode.



- The program No. indicators (1 to 6) blink.

3 Select the program No. to be used.



Select from 1 to 6.

Press within 8 seconds.

- The selected program No. indicator blinks.

4 Specify the day(s) of the week with the numeric keys.



5 Input the ON time with the numeric keys.

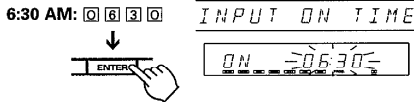

6 Input the OFF time with the numeric keys.



7 Select the PLAY mode.

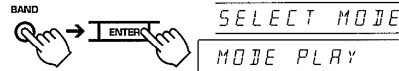

The timer modes are switched between PLAY and REC every time the **[BAND]** key is pressed.

8 Select the CD source.

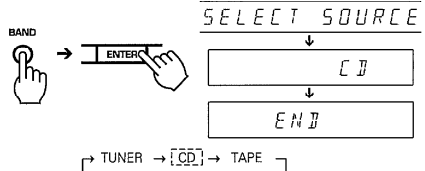

The sources are switched every time the **[BAND]** key is press.

9 Place a disc in the CD player.

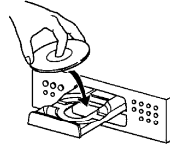

- With the UD-700M, place the disc on the Plus 1 tray and close the door.
- It is not possible to preset a CD playback programs.

10 Activate the execution of the program.



- Select the program No. to be executed by pressing the numeric key under which it is set.

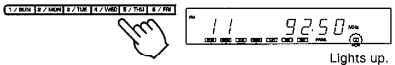

- The selected program No. indicator lights up.

11 Adjust the volume and tone.

12 Switch the power OFF.

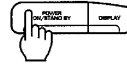

Press the **[POWER]** key of the receiver.

Notes:

- When a program has previously been set in the program No. selected in step 3, the newly-set program replaces the previous program.
- Do not operate the **[CLEAR]** key or **[POWER]** key while the timer program execution has been activated; otherwise malfunction will occur.

To change the program

During the setting operation



After setting is completed

Repeat the programming procedure from step 2.

■ Timer playback of tape

1 Switch the power ON.

Press the [POWER] key of the receiver.

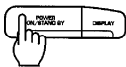

2 Select the program setting mode.



- The program No. indicators (1 to 6) blink.

3 Select the program No. to be used.

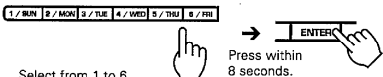

- Select from 1 to 6.
- The selected program No. indicator blinks.

4 Specify the day(s) of the week with the numeric keys.



5 Input the ON time with the numeric keys.

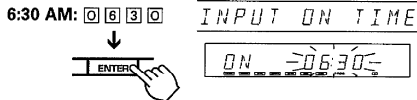

6 Input the OFF time with the numeric keys.

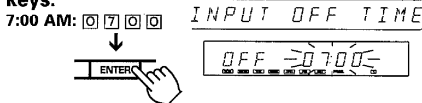

7 Select the PLAY mode.

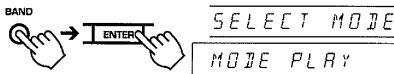

The timer modes are switched between PLAY and REC every time the [BAND] key is pressed.

8 Select the TAPE source.

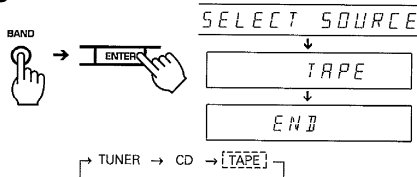

The sources are switched every time the [BAND] key is press.

9 Insert a tape and determine the playback condition.

Select the side(s) to be played and the Dolby NR mode.



- Timer playback is possible with either Deck A or Deck B. However, if tapes are placed in decks, playback will begin from Deck B.

10 Activate the execution of the program.



- Select the program No. to be executed by pressing the numeric key under which it is set.

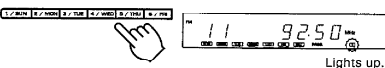

Lights up.

- The selected program No. indicator lights up.

11 Adjust the volume and tone.

12 Switch the power OFF.

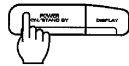

Press the [POWER] key of the power receiver.

Notes:

- When a program has previously been set in the program No. selected in step 3, the newly-set program replaces the previous program.
- Do not operate the [CLEAR] key or [POWER] key while the timer program execution has been activated; otherwise malfunction will occur.

To change the program During the setting operation



After setting is completed

Repeat the programming procedure from step 2.

Be sure to adjust the present time before proceeding the following.

■ Timer recording of radio broadcast

1 Switch the power ON and receive a station to be recorded.

2 Select the program setting mode.



- The program No. indicators (1 to 6) blink.

3 Select the program No. to be used.

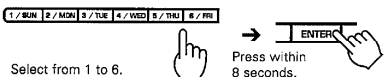

- Select from 1 to 6.
- The selected program No. indicator blinks.

4 Specify the day(s) of the week with the numeric keys.



5 Input the ON time with the numeric keys.



6 Input the OFF time with the numeric keys.



7 Select the REC mode.

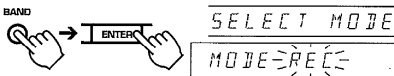

The timer modes are switched between PLAY and REC every time the [BAND] key is pressed.

8 Select the preset key under which the station to be received has been preset.

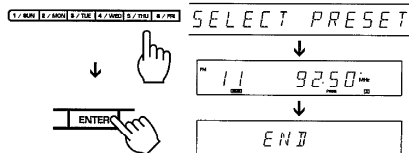

- The station must be preset previously.

9 Set up the cassette deck ready for recording.

- ① Insert a tape in Deck B.
- ② Set the tape transport direction.
- ③ Select the side(s) to be recorded onto.
- ④ Select the Dolby NR mode.
- ⑤ Set the input selector to TUNER.
- ⑥ Press the CRLS key.

- The auto-bias adjustment cannot be used.

10 Activate the execution of the program.



- ② Select the program No. to be executed by pressing the numeric key under which it is set.

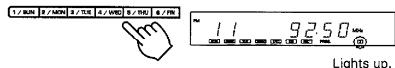

- The selected program No. indicator lights up.

11 Switch the power OFF.

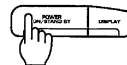

Press the [POWER] key of the receiver.

Notes:

1. When a program has previously been set in the program No. selected in step 3, the newly-set program replaces the previous program.
2. When the power is turned ON by the timer, the volume level is automatically set to the lowest level.
3. Do not operate the [CLEAR] key or [POWER] key while the timer program execution has been activated; otherwise malfunction will occur.

To change the program
During the setting operation



After setting is completed

Repeat the programming procedure from step 2.

Be sure to adjust the present time before proceeding the following.

■ To check timer program contents

1 Press the PROG. key.



2 Press the numeric key corresponding to the program to be checked.

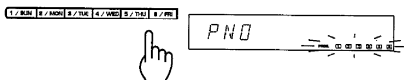

- If no program is selected while the program No. indicators are blinking, the previous display condition resumes.
- When a program is selected, its contents will be displayed for about 3 seconds, and the previous display resumes after it.

■ To cancel timer program execution

1 Press the CLEAR key.



2 Press the numeric key corresponding to the program the execution of which is to be cleared.

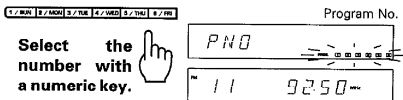

- The program contents are not cleared even when its execution is canceled.

Re-activation of timer execution after canceling it

Since the program itself is retained in memory, check its contents and perform the operation from the step "Activate the execution of the program" as follows.

- ① Press EXE. key.
- ② Select the program No. to be executed by pressing the numeric key under which it is set.
- ③ Adjust the volume and tone in case of timer reception of broadcast or timer playback of CD or tape.
- ④ Switch the power OFF.

■ Operation of one-touch timer

Press the O.T.T. key allows to switch power ON after a specified time period, set in the unit of 30 minutes, from the moment it is activated.

1 Set the timer ON time.

Press the O.T.T. key.



The ON time of the timer is displayed. The displayed time is incremented by 30 minutes every time the key is pressed.

- When the key is pressed once, a time that can be divided by 30 minutes and within 30 minutes from the present time is displayed as the ON time. (Example: When pressed at 7:40, "8:00" will be displayed.)
- The ON time is incremented in 30-minute steps, for example from 0:00 to 0:30, 1:00, 1:30, and so on.
- The ON time can be set up to 12 hours later.
- The one-touch timer can be set even when the power is OFF.

2 Select a program source and adjust the volume.

Select CD, TUNER or TAPE.

3 Switch the power OFF.

Press the POWER key of the receiver.

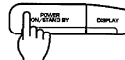

- The ON time can be checked by pressing the O.T.T. key once.
- When the power is switched ON, the sleep timer will automatically be set to 60 minutes.
- When the power is switched ON, the selected source (CD, TAPE, TUNER) will be played.

To cancel one-touch timer activated

Switch the power ON,
or

Press the O.T.T. key until the O.T.T. indicator goes off.

Notes:

1. If disc is not present while the CD input is selected or cassette tape is not present while the TAPE input is selected, the last broadcasting station received will be received again.
2. If the [ADJUST] key is pressed to set the clock, the one-touch timer is released.

After setting the timer, one of the following operations can be added by pressing the AI TIMER keys. The AI TIMER 1 and AI TIMER 2 do not function in the timer recording mode.

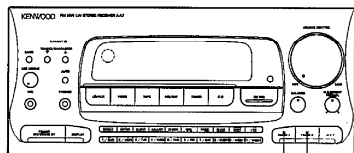

AI TIMER 1 key

AI TIMER 2 key

■ Operation of AI TIMER 1

With this function, when the power is switched ON by the program timer, the volume increases in three steps.

1 Complete the program timer setting.

Switch the power of the receiver OFF.

2 Press the AI TIMER 1 key.

The AI TIMER 1 indicator lights up.

Select the maximum volume.

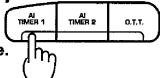

- The maximum volume setting varies every time the key is pressed. When the key is released, the indicator goes out and the maximum volume setting set at that moment is stored in memory.

To cancel the execution of AI TIMER 1

Press the AI TIMER 1 key to select OFF.

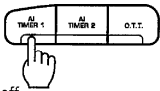

- The AI TIMER 1 indicator goes off.

Reference for volume selection

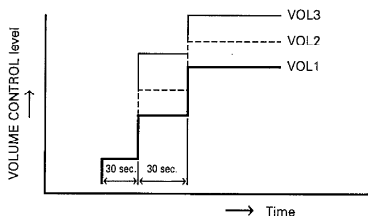

- The VOLUME CONTROL rotates as the volume changes.
- The graphic equalizer curve also varies accordingly.

■ Operation of AI TIMER 2

With this function, when the power is switched ON by the program timer, two tracks on the CD is played first, then the broadcast from the tuner is received automatically. This function is given the highest priority over other program timer functions.

1 Place a disc in the CD player.

- With the UD-700M, place the disc on the Plus 1 tray and close the door.

2 Perform operations of "Timer reception of radio broadcast".

- Refer to page 72.

3 Press the AI TIMER 2 key.

The AI TIMER 2 indicator lights up.

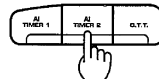

- Also press the AI TIMER 1 key if you want to increase the volume in three steps.

To cancel AI TIMER 2

Press the key again.

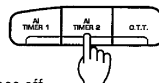

- The AI TIMER 2 indicator goes off.

Notes:

1. When the operation keys of the graphic equalizer or the [VOLUME CONTROL] key and [MUTE] keys on the remote control unit is pressed while the AI TIMER 1 function is carried out, the volume is fixed at the level being set.
2. If the TUNER or TAPE input selector key is selected during the CD playback of AI TIMER 2, the CD playback stops there and the AI TIMER 2 function is canceled.
3. If the operation keys of the CD player is pressed during the CD playback of AI TIMER 2, the CD playback stops there and the AI TIMER 2 function is canceled.
4. If the CD has not been inserted, reception of radio broadcast starts at the moment AI TIMER 2 is activated.
5. Even when the program timer operation has completed, the AI TIMER 1 and 2 indicators do not go off. Be sure to turn off the indicators when the AI TIMER 1 and / or 2 is not required any more.

Operation of timer

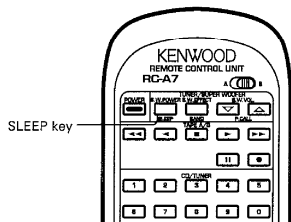

■ Operation of sleep timer

The sleep timer allows to turn the system power off after the specified period has elapsed. This function may be most convenient when you like to fall in sleep while listening to music.

The period can be set up to 90 minutes in 10-minute steps.

The sleep timer is applied in priority over other timer programs.

Remote control unit only

1 Switch the power ON.

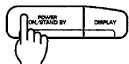

Press the **POWER** key of the receiver.

2 Specify the period after which the power is to be switched OFF.

Press the **SLEEP** key.

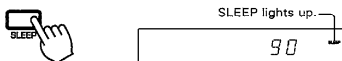

→ 90 → 80 → 70 → → 20 → 10 → Canceled

- Each press decreases the period by 10 minutes.

To cancel sleep timer

Press the **SLEEP** key until the sleep timer is canceled,

or
Switch the power OFF.

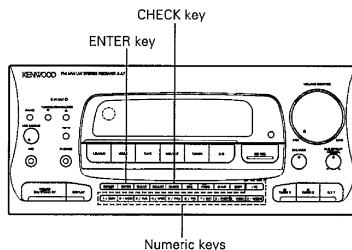

■ Operation of calendar check

The calendar check allows to display the day of the week of the specified date input by the user in the order of year, month and day. This function covers the range from January 1, 1900 to December 31, 2099.

1 Press the CHECK key.

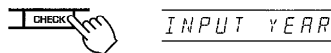

2 Input the year with the numeric keys.

Year 1992: [1] [9] [9] [2]

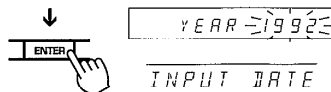

3 Input the month then the day with the numeric keys.

March 30: [0] [3] [3] [0]

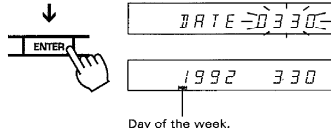

- The day-of-the-week indicator of the date input above lights up. The previous display resumes in a few seconds.

In case of difficulty

What appears to be a malfunction may not always be serious. If your unit should not perform as expected, consult the table below to see if the problem can be corrected before seeking help from your dealer or service representative.

Remote control unit

Symptom	Cause	Remedy
Remote control operation is not possible.	<ul style="list-style-type: none"> Batteries are exhausted. The parallel cord is not connected properly. The remote control unit is too far away from the main system, controlling angle is too large, or there is an obstacle in between. The source component to be operated does not contain the tape(s) or CD. An attempt is made to play a tape which is being recorded in the cassette deck. 	<ul style="list-style-type: none"> Replace with new batteries. Connect properly referring to "System connections". Operate the remote control unit within the controllable range. Place the tape(s) or CD in the source component to be played. Wait until the recording is completed.

Receiver unit, speakers

Symptom	Cause	Remedy
Sound is not output.	<ul style="list-style-type: none"> The speaker cords are disconnected. The volume is set to minimum position. The [MUTE] key of the remote control unit is set to ON and the point indicator is blinking. The parallel cord is not connected properly. The headphones plug is left inserted in the PHONES jack. 	<ul style="list-style-type: none"> Connect properly referring to "System connections". Adjust the volume to a proper level. Press the [MUTE] key to OFF. Connect properly referring to "System connections". Remove the plug.
No sound comes out, and "PROTECT" is shown on the display.	<ul style="list-style-type: none"> Speaker cords are short-circuited. 	<ul style="list-style-type: none"> Turn the power off, eliminate the short-circuiting, then turn on the power again.
Sound is not output from one of the speakers.	<ul style="list-style-type: none"> The speaker cord is disconnected. The BALANCE control is set to an extreme position. 	<ul style="list-style-type: none"> Connect properly referring to "System connection". Adjust the Left / Right balance.
Sound from the surround rear speaker is not output or too small.	<ul style="list-style-type: none"> The rear speaker cord is disconnected. The Surround play mode has not been engaged. The REAR LEVEL control is set to the minimum level. 	<ul style="list-style-type: none"> Connect properly referring to "System connections". Set the Dolby Surround or DSP presence mode. Adjust the REAR LEVEL control.
The clock display is blinking without changing from a certain time.	<ul style="list-style-type: none"> There was a power failure. The power cord was unplugged. 	<ul style="list-style-type: none"> Set the current time again. Set the current time again.
The timer does not work.	<ul style="list-style-type: none"> The current time is not set, or there was a power failure. The timer ON time and OFF time have not been set. The timer execution has not been specified. 	<ul style="list-style-type: none"> Set the current time referring to "Time adjustment". Set the timer ON time and OFF time. Specify execution by pressing the [EXE] key.
Radio stations cannot be received.	<ul style="list-style-type: none"> No antenna is connected. The broadcast band is not set properly. The frequency of the desired station is not tuned. 	<ul style="list-style-type: none"> Connect an antenna. Set the broadcast band properly. Tune the frequency of the desired station.

In case of difficulty

Symptom	Cause	Remedy
A station which was preset cannot be received by pressing the corresponding numeric key.	<ul style="list-style-type: none"> The preset station belongs to a frequency that cannot be received. The preset memory was cleared because the power cord had been unplugged for a long period of time. 	<ul style="list-style-type: none"> Preset a station with a receivable frequency. Preset the station again.
Interference.	<ul style="list-style-type: none"> Noise due to ignition noise of an automobile. Noise due to an influence from an electric appliance. Noise due to a nearby TV set. 	<ul style="list-style-type: none"> Install the outdoor antenna apart from the road. Turn off the power of the appliance. Install the system more apart from the TV set.

Cassette decks

Symptom	Cause	Remedy
Sounds is not produced when the Play key is pressed.	<ul style="list-style-type: none"> The parallel cord is not connected properly. The head is dirty. Tape is irregularly wound and hard to take up. A non-recorded tape is being played. 	<ul style="list-style-type: none"> Connect properly referring to "System connections". Clean the head referring to "Cleaning the head section". Replace the tape. Play a recorded tape.
The deck does not work when an operation key is pressed.	<ul style="list-style-type: none"> The cassette holder is not closed completely. The operation key was pressed immediately after closing the cassette holder. The operation key was pressed within less than 3 seconds after the power was turned on. Tape is not inserted. Tape is irregularly wound and hard to take up. Tape has been fully wound to reel. 	<ul style="list-style-type: none"> Close the cassette holder completely. Press the desired operation key in a few seconds after closing the cassette holder. Press the desired operation key in more than 3 seconds after turning the power on. Insert a tape. Replace the tape. Change the tape transport direction or insert the tape inversely.
DPSS malfunctions.	<ul style="list-style-type: none"> The tape is not suitable for DPSS operation, for example the spaces between tunes are too short. 	<ul style="list-style-type: none"> Read "DPSS operation".
CCRS does not work.	<ul style="list-style-type: none"> A recordable tape is not inserted in Deck B. A disc is not placed in the CD player. The disc is dirty. 	<ul style="list-style-type: none"> Insert a recordable tape in Deck B and press the [CCRS] key. Place a disc in the CD player and press the [CCRS] key. Clean the disc, place it in the CD player, and press the [CCRS] key.
The dubbing on Deck A and Deck B ends at different timing.	<ul style="list-style-type: none"> This is due to the difference in tape length or to the characteristics of the cassette deck mechanisms. 	<ul style="list-style-type: none"> A small time difference is not regarded as a failure.
The cassette holder does not open when the Eject key is pressed.	<ul style="list-style-type: none"> The key is pressed during recording or playback. 	<ul style="list-style-type: none"> Press in the Stop mode.
Sound is hoarse, or high frequencies are not audible.	<ul style="list-style-type: none"> The head is dirty. The tape is stretched or wrinkled. 	<ul style="list-style-type: none"> Clean the head referring to "Cleaning the head section". Replace the tape.
Sound is distorted.	<ul style="list-style-type: none"> The recording level has not been set by the [CRLS] key. A tape recorded with distorted sound is being played. 	<ul style="list-style-type: none"> Adjust the recording level referring to "Recording operation on cassette deck". Replace the tape.

Symptom	Cause	Remedy
Recording is not initiated when the Recording key is pressed.	<ul style="list-style-type: none"> ● The protection tab on the cassette has been broken. ● The cassette holder is not closed completely. ● The TAPE input selector is selected on the receiver. ● Tape has been fully wound to a reel. 	<ul style="list-style-type: none"> ● Use a cassette with unbroken tab or close the hole. ● Close the cassette holder completely. ● Press the input select key of the source to be recorded. ● Change the tape transport direction of Deck B or insert the tape inversely.
Noise level is high.	<ul style="list-style-type: none"> ● The head is magnetized. ● External noise is induced. ● A tape recorded with Dolby NR ON is being played with Dolby NR OFF. 	<ul style="list-style-type: none"> ● Demagnetize the head referring to "Cleaning the head section". ● Install the system apart from other electrical appliances and TV set. ● The [DOLBY NR] selector switch to B or C.
Sound is vibrating.	<ul style="list-style-type: none"> ● The capstans or pinch rollers are dirty. ● Tape is irregularly wound. 	<ul style="list-style-type: none"> ● Clean the head referring to "Cleaning the head section". ● Wind the tape regularly by fast forwarding, rewinding or playing it fully from one reel to another.

CD player

Symptom	Cause	Remedy
Disc is loaded, player does not play.	<ul style="list-style-type: none"> ● Disc is loaded upside down. ● Disc is loose. ● Disc is dirty. ● Disc is cracked. ● Condensation occurred on the optical lens unit. 	<ul style="list-style-type: none"> ● Load the disc again with its label side up. ● Insert the disc properly. ● Wipe off the dust on the surface of the disc referring to "Disc handling precautions". ● Replace the disc with a new one. ● Remove condensed dew by referring to "Beware of condensation".
No sound.	<ul style="list-style-type: none"> ● Disc is not loaded. ● Play mode is not entered (The play/pause indicator is not lit.) ● Disc is too dirty. ● Disc is cracked. ● The parallel cord is not connected properly. 	<ul style="list-style-type: none"> ● Load a disc. ● Press the [P/T] key. ● Wipe off the dust on the disc surface referring to "Disc handling precautions". ● Replace the disc with a new one. ● Connect properly referring to "System connection".
Music is interrupted. (Sound is skipped.)	<ul style="list-style-type: none"> ● Disc is too dirty. ● Disc is cracked. ● Oscillation is applied to this unit. 	<ul style="list-style-type: none"> ● Wipe off the dust on the disc surface referring to "Disc handling precautions". ● Replace the disc with a new one. ● Try selecting a place where no strong vibrations occur by changing the installation place, etc.

Notes:

1. With some tapes, a squeaky noise is produced when the tape is stopped automatically. This is due to the tape protection function, and not a malfunction.
2. Do not use 120-minute tapes, for the tape is too thin and gets easily tangled.
3. This system is microprocessor-controlled, so malfunction may occur due to external noise or interference noise. In such a case, unplug the power cord, plug it while pressing the [ENTER] key and turn power on again.
4. Do not use contact cleaners because it could cause a malfunction. Be specially careful against contact cleaners containing oil, for they may deform the plastic components.

Specifications (For U.K. and Europe)

Receiver unit (A-A7L)

Amplifier section

Rated power output

(IEC / NF) From 63 Hz to 12,500 Hz, 0.7 % T.H.D.

at 4 Ω 35 W + 35 W

(DIN) 1 kHz at 4 Ω 35 W + 35 W

Presence

1 kHz at 8 Ω 20 W + 20 W

Total harmonic distortion

..... 0.09 % (40 Hz ~ 20 kHz, 1 / 2 rated power, 4 Ω)

..... 0.06 % (1 kHz, 1 / 2 rated power, 4 Ω)

Signal to noise ratio

LD / AUX, VIDEO, MD / DAT

..... 100 dB (IHF'66) / 80 dB (IHF'78)

Input sensitivity / Impedance

LD / AUX, VIDEO, MD / DAT 150 mV / 47 k Ω

N.B. circuit (-30 dB Volume level) (Max) + 15 dB
(at 60 Hz)

Output level / Impedance

SUPER WOOFER OUT 1.5 V / 3.6 k Ω

VIDEO section

Input level impedance

VIDEO (composite) 1 Vp-p / 75 Ω

Input (LD / AUX, VIDEO IN)

Output level impedance

VIDEO (composite) 1 Vp-p / 75 Ω

Output (MONITOR, VIDEO OUT)

FM Tuner section

Tuning frequency range 87.5 MHz ~ 108 MHz

Sensitivity (DIN at 75 Ω)

MONO 0.7 μ V / 8.2 dBf

Total harmonic distortion (DIN at 1 kHz)

MONO 0.6 % (65.2 dBf input)

STEREO 0.8 % (65.2 dBf input)

Signal to noise ratio (DIN weighted at 1 kHz)

MONO 70 dB (65.2 dBf input)

STEREO 64 dB (65.2 dBf input)

Selectivity (DIN \pm 300 kHz) 60 dB

Stereo separation (DIN)

1 kHz 40 dB

Frequency response 30 Hz ~ 15 kHz, + 0.5 dB, - 3 dB

MW Tuner section

Tuning frequency range 531 kHz ~ 1,602 kHz

Usable sensitivity 10 μ V / (500 μ V / m)

Signal to noise ratio

(at 30 % mod. 1 mV input) 48 dB

LW Tuner section

Tuning frequency range 153 kHz ~ 281 kHz

Usable sensitivity 22 μ V

Signal to noise ratio

(at 30 % mod. 1 mV input) 45 dB

[General]

Power consumption 170 W

Dimensions W: 270 mm (10-5 / 8")

H: 120 mm (4-3 / 4")

D: 332 mm (13-1 / 16")

Weight (net) 6.5 kg (14.3 lb)

Note:

KFNWOOD follows a policy of continuous advancements in development. For this reason specifications may be changed without notice.

Strömbrytarens POWER beredskapsläge

Indikatorn STAND BY tänds efter nätkabelns anslutning till ett vägguttag, oavsett strömbrytarens POWER till/frånslag. Detta anger att en liten mängd ström leds till komponenten som stöd för minnesinhållet.

Detta läge kallas för beredskapsläget. Strömbrytaren på fjärrkontrollen kan användas för att slå på och av strömmen så länge indikatorn STAND BY lyser.

Virtanäppäimen (POWER) valmiustila (STAND BY)

Kun laitteen verkkokojohto on liitetty pistorasiaan, valmiustilan merkkivalo syttyy riippumatta virtanäppäimen (POWER) asennosta (ON / OFF).

Merkkivalo osoittaa, että laitteessa on hieman virtaa muistien sisältöjen ylläpitoa varten. Tätä tilaa kutsutaan valmiustilaksi. Kun valmiustilan merkkivalo (STAND BY) palaa, laitteen virta voidaan kytkeä ja katkaista kaukosäätimellä.

Afbrydertastens (POWER) STAND BY funktion

Når apparatets strømledning er tilsluttet en stikkontakt, lyser STAND BY indikatoren, uanset om der er tændt ved afbryderen på apparatet eller ej. Det angiver, at apparatet bliver forsynet med en ganske lille mængde strøm til opret-holdelse af hukommelsens indhold.

Denne funktion kaldes STAND BY. Når STAND BY-indikatoren er tændt, kan strømmen til apparatet slås til og fra med fjernstyr-ringsenheden.

PÅ/AV-knappens Stand-by funksjon

Når strømledningen til dette anlegget er satt i en vekselsstrømskontakt, vil STAND-BY indikatorlampen lyse enten PÅ/AV-knappen er på- eller avslått. Dette betyr at en viss mengde strøm tilføres anlegget slik at innholdet i minnet ikke går tapt.

Denne funksjonen kalles Stand-by. Når indikatorlampen for STAND-BY er tent, kan strømmen slås PÅ / AV fra fjernkontrollen.

Specifications (For other countries)

Receiver unit (A-A7)

Amplifier section

Rated power output
For U.S.A. and Canada

30 watts per channel minimum RMS, both channels driven, at 4 Ω from 40 Hz to 20,000 Hz with no more than 0.09 % total harmonic distortion

Presence
1 kHz at 8 Ω 18 W + 18 W

For other countries

(EIAJ 4 Ω) 45 W + 45 W
(IHF'66) From 40 Hz to 20 kHz, 0.09 % T.H.D.
at 4 Ω 35 W + 35 W
(IEC / NF) From 63 Hz to 12,500 Hz, 0.7 % T.H.D.
at 4 Ω 35 W + 35 W

Presence
1 kHz at 8 Ω 25 W + 25 W (EIAJ)

Total harmonic distortion

..... 0.09 % (40 Hz ~ 20 kHz, 1 / 2 rated power, 4 Ω)
..... 0.06 % (1 kHz, 1 / 2 rated power, 4 Ω)

Signal to noise ratio

LD / AUX, VIDEO, MD / DAT
..... 100 dB (IHF'66) / 80 dB (IHF'78)

Input sensitivity / Impedance

LD / AUX, VIDEO, MD / DAT 150 mV / 47 k Ω
MIC 1.2 mV / 47 k Ω
(Except for U.S.A and Canada)

N.B. circuit (-30 dB Volume level) (Max) + 15 dB
(at 60 Hz)

Output level / Impedance

SUPER WOOFER OUT 1.5 V / 3.6 k Ω

VIDEO section

Input level impedance
VIDEO (composite) 1 Vp-p / 75 Ω
Input (LD / AUX, VIDEO IN)
Output level impedance
VIDEO (composite) 1 Vp-p / 75 Ω
Output (MONITOR, VIDEO OUT)

FM Tuner section

Tuning frequency range 87.5 MHz ~ 108 MHz
Sensitivity (MONO at 75 Ω) 1.2 μ V / 12.8 dBf
Total harmonic distortion (at 1 kHz)
MONO 0.5 % (65 dBf input)
STEREO 0.6 % (65 dBf input)
Signal to noise ratio at 1 kHz
MONO 80 dB (85 dBf input)
STEREO 74 dB (85 dBf input)
Selectivity (\pm 400 kHz) 50 dB
Stereo separation
1 kHz 40 dB
Frequency response 30 Hz ~ 15 kHz, + 0.5 dB, - 3 dB

AM Tuner section

Tuning frequency range
9 kHz step 531 kHz ~ 1,602 kHz
10 kHz step 530 kHz ~ 1,610 kHz
or 530 kHz ~ 1,700 kHz
(for U.S.A. and Canada)
Usable sensitivity 10 μ V / (500 μ V / m)
Signal to noise ratio
(at 30 % mod. 1 mV input) 48 dB

[General]

Power consumption 170 W
Dimensions W: 270 mm (10-5 / 8")
H: 120 mm (4-3 / 4")
D: 332 mm (13-1 / 16")
Weight (net) 6.5 kg (14.3 lb)

Note:

KENWOOD follows a policy of continuous advancements in development. For this reason specifications may be changed without notice.

For the U.S.A.

Note to CATV system installer:

This reminder is provided to call the CATV system installer's attention to Article 820-40 of the NEC that provides guidelines for proper grounding and, in particular, specifies that the cable ground shall be connected to the grounding system of the building, as close to the point of cable entry as practical.

For the U.S.A.

FCC WARNING:

This equipment may generate or use radio frequency energy. Changes or modifications to this equipment may cause harmful interference unless the modifications are expressly approved in the instruction manual. The user could lose the authority to operate this equipment if an unauthorized change or modification is made.

NOTE:

This equipment has been tested and found to comply with the limits for a Class B digital device, pursuant to Part 15 of the FCC Rules. These limits are designed to provide reasonable protection against harmful interference in a residential installation. This equipment may cause harmful interference to radio communications, if it is not installed and used in accordance with the instructions. However, there is no guarantee that interference will not occur in a particular installation. If this equipment does cause harmful interference to radio or television reception, which can be determined by turning the equipment off and on, the user is encouraged to try to correct the interference by one or more of the following measures:

- Reorient or relocate the receiving antenna.
- Increase the separation between the equipment and receiver.
- Connect the equipment into an outlet on a circuit different from that to which the receiver is connected.
- Consult the dealer or an experienced radio / TV technician for help.

Specifications

Graphic equalizer unit (GE-A7)

Equalizer characteristics variable range ± 10 dB
Individual channel adjust:
60 Hz, 150 Hz, 400 Hz, 1 kHz, 2.4 kHz, 6 kHz, 15 kHz

[General]

Dimensions W: 270 mm (10-5 / 8")
H: 85 mm (3-3 / 8")
D: 269 mm (10-9 / 16")
Weight (net) 1.8 kg (3.97 lb)

CD player unit (DP-A9)

Laser Semiconductor laser
Playing rotation 200 rpm ~ 500 rpm (CLV)
Frequency response 20 Hz ~ 20 kHz, ± 0 dB, -1.5 dB
Signal to noise ratio More than 93 dB
Total harmonic distortion
..... Less than 0.01 % (at 1 kHz)
Channel separation More than 85 dB (at 1 kHz)
Wow & Flutter Unmeasurable Limit

[General]

Dimensions W: 270 mm (10-5 / 8")
H: 85 mm (3-3 / 8")
D: 259 mm (10-3 / 16")
Weight (net) 2.0 kg (4.4 lb)

CD player unit (DP-MA9)

Laser Semiconductor laser
Playing rotation 200 rpm ~ 500 rpm (CLV)
Frequency response 20 Hz ~ 20 kHz, ± 1.0 dB
Signal to noise ratio More than 93 dB
Total harmonic distortion
..... Less than 0.01 % (at 1 kHz)
Channel separation More than 85 dB (at 1 kHz)
Wow & Flutter Unmeasurable Limit

[General]

Dimensions W: 270 mm (10-5 / 8")
H: 85 mm (3-3 / 8")
D: 310 mm (12-3 / 16")
Weight (net) 3.2 kg (7.0 lb)

Cassette deck unit (X-A9)

Track 4-track, 2-channel stereo
Recording system AC bias system
(Frequency: 105 kHz)

Heads

A deck Playback head 1
B deck Playback / recording head 1
Erasing head 1

Motors

A deck 1
B deck 1
Fast winding time Approx. 110 seconds
(C-60 tape)

Frequency response

Normal tape 35 Hz to 17,000 Hz, ± 3 dB
CrO₂ tape 35 Hz to 18,000 Hz, ± 3 dB
Metal tape 35 Hz to 18,000 Hz, ± 3 dB

Signal to noise ratio

Dolby C NR ON 74 dB (Metal tape)
Dolby B NR ON 66 dB (Metal tape)
Dolby NR OFF 58 dB (Metal tape)

Wow and flutter 0.09 % (W.R.M.S.)
 ± 0.19 % (DIN)
Harmonic distortion Less than 0.9 %
(at 1 kHz, 3rd H.D. Metal tape)

[General]

Dimensions W: 270 mm (10-5 / 8")
H: 120 mm (4-3 / 4")
D: 259 mm (10-3 / 16")
Weight (net) 2.7 kg (5.9 lb)

Speakers (LS-A6)

Enclosure Bass-reflex type
Speaker configuration 2-Way system
Woofer 150 mm, cone type
Tweeter 25 mm, dome type
Impedance 4 Ω
Maximum input level 60 W
Frequency response 43 Hz ~ 20 kHz

[General]

Dimensions W: 205 mm (8-1 / 16")
H: 410 mm (16-1 / 8")
D: 250 mm (9-13 / 16")
Weight (net) 5.1 kg (11.2 lb) (1 piece)

Note:

KENWOOD follows a policy of continuous advancements in development. For this reason specifications may be changed without notice.